

SKIPPER

2 Axis Doppler Speed Log

DL850 (270 kHz)

Operation and Installation Manual

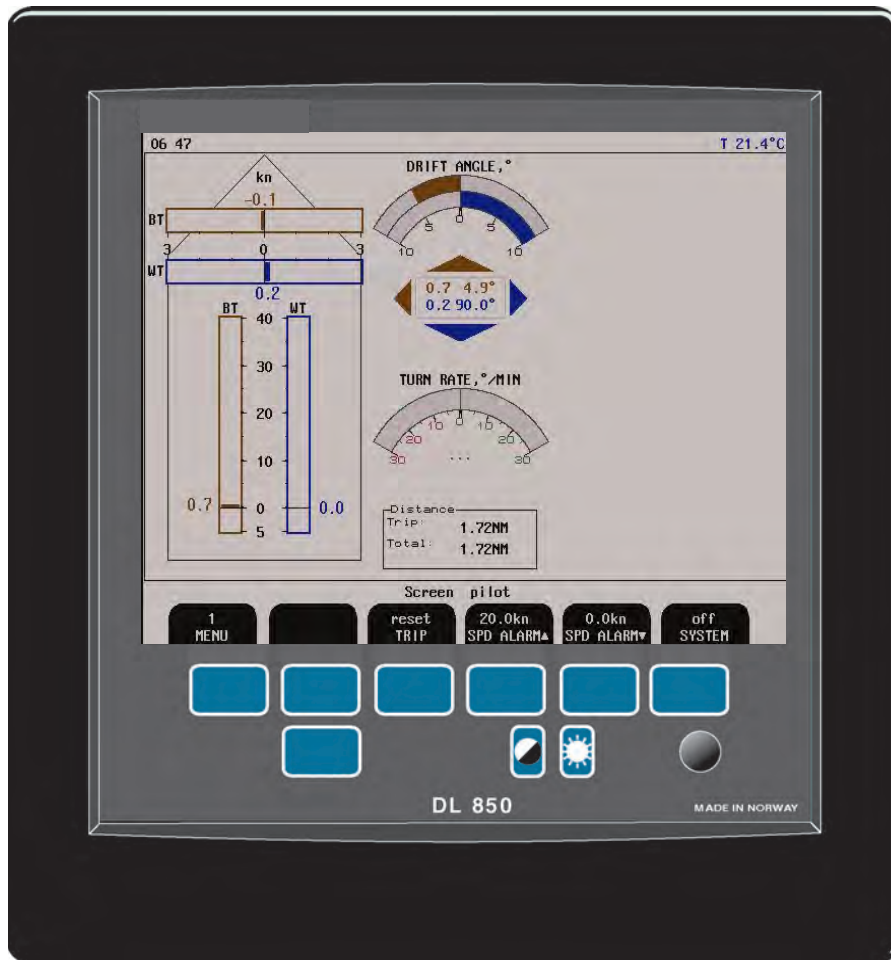

SKIPPER Electronics AS
Enebakkveien 150
P. O. Box 151, Manglerud
0612 Oslo, Norway
www.skipper.no

Telephone: +47 23 30 22 70
Telefax: +47 23 30 22 71
E-mail: support@skipper.no
Co. reg. no: NO-965378847-MVA

Document no: **DM-D002-SC**
Edition: 2012-11-20
Rev: 4.03.03

Information

Please visit our web site www.skipper.no for additional information. Here you will find product bulletins, software updates, instruction manuals, installation procedures etc.

Important

- During installation, **DO NOT CUT THE TRANSDUCER CABLE.** The transducer, transducer cable and transceiver cabinet are all “balanced parts”. Therefore cutting the cable may deteriorate performance and will also void the warranty.
- During installation, consideration must be taken, such that the sensor and cable can be removed for service purposes. Filling pipes or tubes is **not** recommended unless strictly necessary.

Weitergabe sowie vervielfältigung dieser unterlage, verwertung und mitteilung ihres inhaltes nicht gestattet, soweit nicht ausdrücklich zugestanden. Zuwiderhandlungen verpflichten zu schadenersatz.

Toute communication ou reproduction de ce document, toute exploitation ou communication de ou son contenu sont interdites, sauf autorisation expresse. Tout manquement à cette règle est illicite et expose son auteur au versement de dommages et intérêts.

Copying of this document, and giving it to others and the use or communication of contents thereof, are forbidden without express authority. Offenders are liable to the payment of damages.

Sin nuestra expresa autorización, queda terminantemente prohibida la reproducción total o parcial de este documento, así como su uso indebido y/o su exhibición o comunicación a terceros. De los infractores Se exigirá el correspondiente resarcimiento de daños y perjuicios.

Contents

1. INTRODUCTION.....	6
System Summary	6
Sensor (Transducer) and Transceiver.....	6
Operator Unit	7
Interfacing.....	7
Outputs	7
Inputs.....	7
Alarms	7
2. OPERATION.....	10
Parameter entry	10
Primary Screens	11
Screen pilot, Menu 1, trip/speed alarm.	12
Screen pilot, Menu 2, system.	13
Screen shallow water, (only in non docking version).	14
Screen docking, arrow view (only in docking version).	15
Screen docking, bar graph view (only in docking version).	16
Screen open sea, system.....	17
Setup and Function Control Screens.....	18
Screen com, Menu 1, NMEA setup.....	19
Screen com, Menu 2, NMEA com setup.....	20
Screen status, Menu 1, units.....	22
Screen status, Menu 2, date/time.....	23
Screen status, Menu 3, boat setup/buzzer.....	23
Screen status, Menu 4, pulse settings.....	24
Screen status, Menu 5, analogue settings.....	24
Screen status, Menu 6, speed limits and hysteresis.....	25
Screen status, Menu 7, signal good/signal suspected.....	25
Screen status, Menu 8, speed test/demo (simulate).....	25
Screen calibration, Menu 1, calibration.	26
Screen calibration, Menu 2, manual override	27
Screen calibration, Menu 3, mounting settings	27
Screen diagnostics, Menu 1, settings.	28
Screen diagnostics, Menu 2, filtering/averaging	29
Screen diagnostics, Menu 3, BT settings	29
Principal Functions	30
Doppler Log Principle.....	30
Bottom Track Characteristics.....	30
Water Track Characteristics	30
Echo sounder option.....	30
Non-volatile Parameter Memory.....	31
Fixed Key Functions	31
Screen Select	31
Backlight adjustment (brightness).....	31
Day/Night.....	31
Soft Key Functions	32
Speed limits functionality	33
3. USER MAINTENANCE	34
Transducer Maintenance	34
Operator Unit and Transceiver Unit Maintenance	34

4. INSTALLATION	35
Handling warning.....	35
Transducer Installation.....	36
Location.....	36
Operator Unit Installation	36
115/230 V selection on Combo Terminal board inside Display Unit.....	36
AC Voltage selection.....	37
Fuses.....	37
Back-up Battery Jumper JP200.....	38
Power indication and function LEDs.....	39
Old PLD version in Transceiver Unit.....	40
Interfacing	41
Alarm relay.....	41
Log Pulse Outputs	41
Speed Limit function.....	41
Inputs.....	42
Analogue interfaces.....	42
NMEA interface	42
Options.....	42
Repeaters/Slaves	42
External Interface Ports.....	43
Operator Unit - Connecting External Equipment	44
Operator unit - Terminal connections	45
Misc I/O connections	46
Alarm connections	47
5. START-UP AND SYSTEM ADAPTION.....	48
System Adaption	48
Analogue outputs and log pulse outputs range selection	48
Units of Measure.....	48
NMEA Setup	48
Doppler log transmitted (talker) (IEC 61162-1:2007(E) (NMEA 0183) messages:	49
Docking option parameter setup	50
6. CALIBRATION PROCEDURE	51
Calibration routine:	52
Activation of the hidden menus	52
Step 1. Heading error correction:	53
Step 2a. Manual speed calibration/adjustment:.....	53
Step 2b. Semi Automatic calibration:	54
7. TROUBLE SHOOTING	56
Basic System Integrity	56
Installation problems.....	57
Interface problems	58
Basic functionality	58
Typical Status Screen Contents.....	59
Typical diagnostic screen contents.....	61
Master reset procedure.....	64
8. SPECIFICATIONS.....	65
Dimensions	65

Functional Properties	65
Performance	66
Environmental	66
9. SERVICE	67
10. APPENDIX 1	68
Miscellaneous Installation Diagrams	68
PCB positions in Transceiver Unit	69
LEDs on PCBs in Transceiver Unit	70
DL 850 System Overview	71
Operator Unit - Transceiver Unit Interconnection	72
270 kHz Sensor Cable Connection	73
Transceiver Unit Dimensions	74
Dimensional Drawing Cabinet	75
115/230 V selection on backplane inside Transceiver Unit	76
Cable gland connector	77
11. APPENDIX 2	78
Upgrading Software	78
CPU PCA-6742VE setup	79
12. APPENDIX 3	80
The echo sounder function	80
Screen pilot, Menu 1, trip/speed alarm.	80
Screen pilot, Menu 2, ES mode settings.	81
Screen Diagnostics, Menu 3, ES mode, SL BT mode, GPS->BT	81
13. NOTES	82
14. INDEX.....	83

1. Introduction

System Summary

The system is a navigation, 2 axis (transversal and longitudinal) Doppler speed log with a large LCD. The display graphics is continuously shown on the LCD along with available navigation details. Comprehensive interfaces are available including IEC 61162-1:2007(E) (NMEA 0183) input and output. All IMO (International Maritime Organization) requirements for speed logs are met or exceeded.

Sensor (Transducer) and Transceiver

The Doppler sensor consists of a head with hydro-acoustic elements. Two different versions of the sensor head (270 kHz and 540 kHz) exist, both with 2 axis log function. The 540 kHz, has in addition, one extra element for the auxiliary echo sounder option. The sensor is connected to a transceiver cabinet located within 40 m of the sensor.

The connection from the transceiver cabinet to the operator unit is via a serial RS-422 data link and may be up to 1000 m. Transceiver and operator unit power supply options are 115/230 V AC or 24 V DC. The power consumption for the transceiver unit is app. 80 Watt at 115/230 V AC or 60 Watt at 24 V DC.

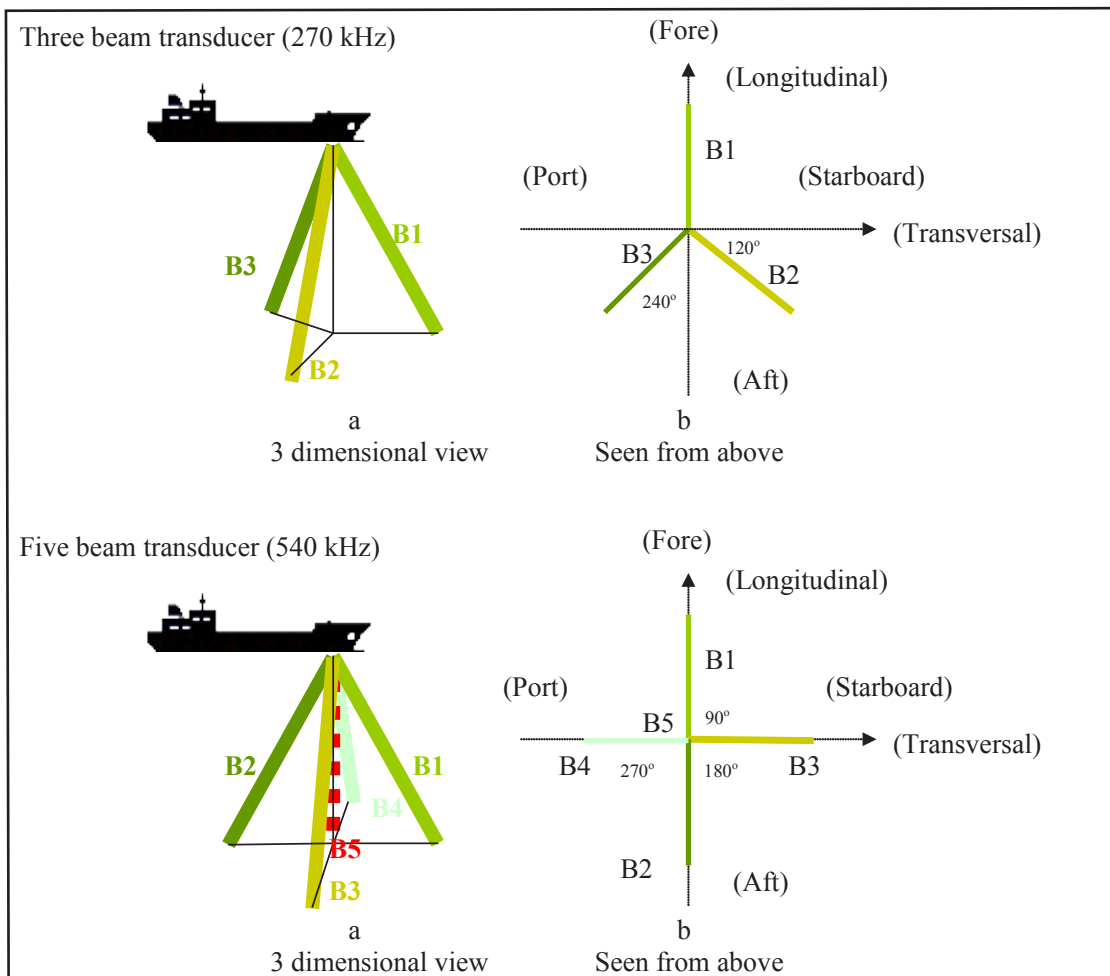

Operator Unit

The operator unit contains a graphic LCD display and a keyboard with fixed keys, softkeys and a rotating encoder. The function of each softkey button depends on the active screen, and the buttons are labelled on the lower rim of the LCD. The display is back lit, and back light intensity may be adjusted by the user. Various user-selectable information layouts adapted to typical operational situations, may be displayed continuously on the LCD. The operator unit can be flush mounted, wall mounted or bracket mounted. Operator unit power supply options are 115/230 V AC or 24 V DC. The power consumption is app. 70 Watt at 115/230 V AC or 50 Watt at 24 V DC.

Interfacing

The display unit has various interface possibilities.

Outputs

- 3 log pulse outputs 10/100/200/400/1000 pulses per nautical mile, see “[Log Pulse Outputs](#)” on [page 41](#).
- 2 outputs also gives speed direction, see “[Log Pulse Outputs](#)” on [page 41](#).
- 3 analogue outputs 0 - 10 V or 4 - 20 mA, see “[Analogue interfaces](#)” on [page 42](#).
- IEC 61162-1:2007(E) (NMEA 0183) interface output of speed/distance, temperature, alarm and depth information, see “[NMEA Setup](#)” on [page 48](#).
- Functional alarm relay, see “[Alarm relay](#)” on [page 41](#).
- Power failure alarm, see “[Alarm relay](#)” on [page 41](#).
- Speed limit alarm, see “[Speed Limit function](#)” on [page 41](#).
- External VGA monitor, see “[External Interface Ports](#)” on [page 43](#).

Inputs

- IEC 61162-1:2007(E) (NMEA 0183) interface input for alarm, position, rate of turn, heading and UTC (Coordinated Universal Time), see “[NMEA Setup](#)” on [page 48](#)
- External alarm reset, see “[Inputs](#)” on [page 42](#).

Alarms

High and low speed alarms may be selected from the menus (screen pilot, menu 1). Alarms are provided on both a potential free relay contact and as NMEA messages. Both ways can be used for interface to external alarm systems. An optocoupler output is used as a separate output for power failure alarm.

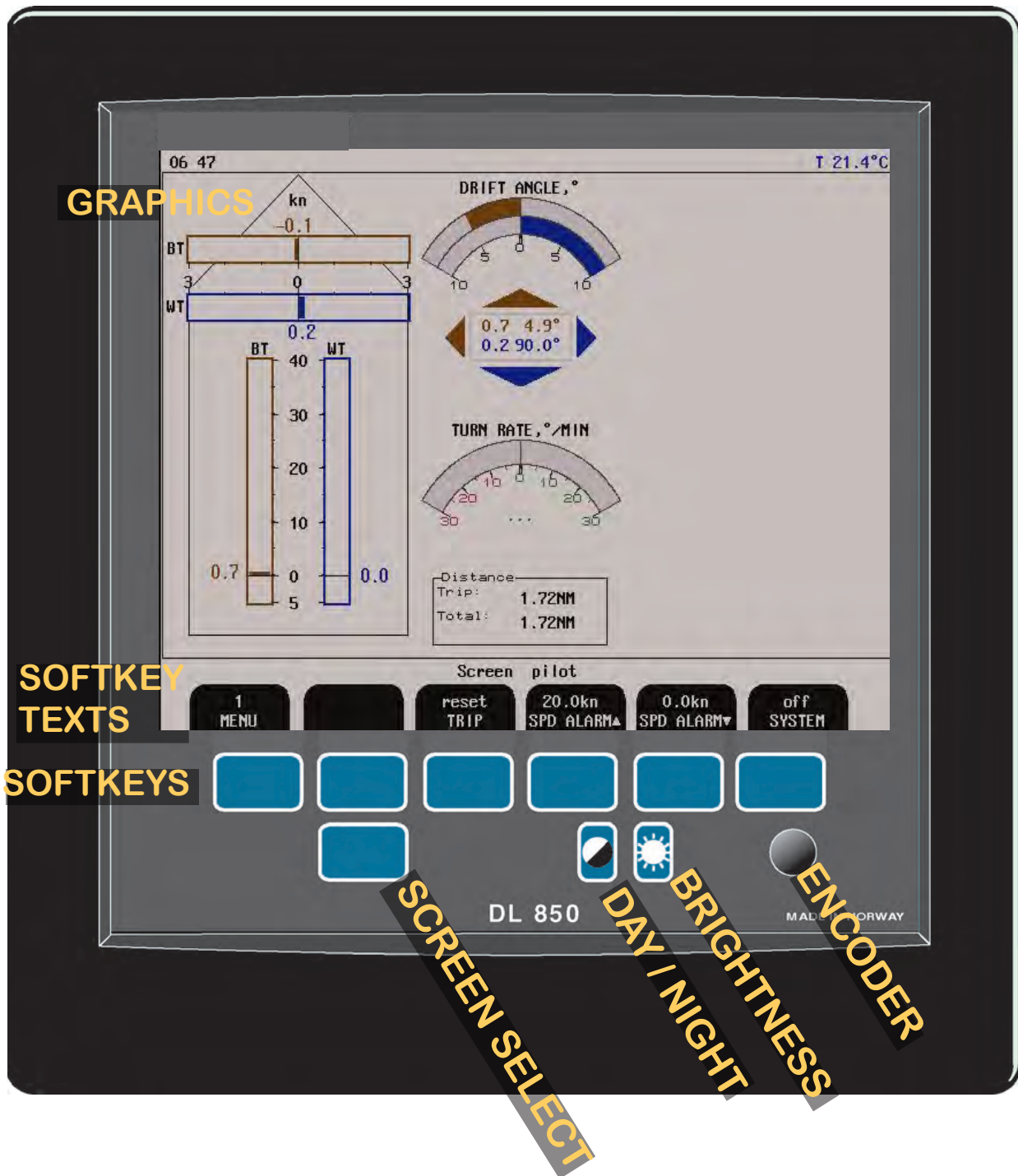

Fig. 1.1 Operator unit, panel layout.

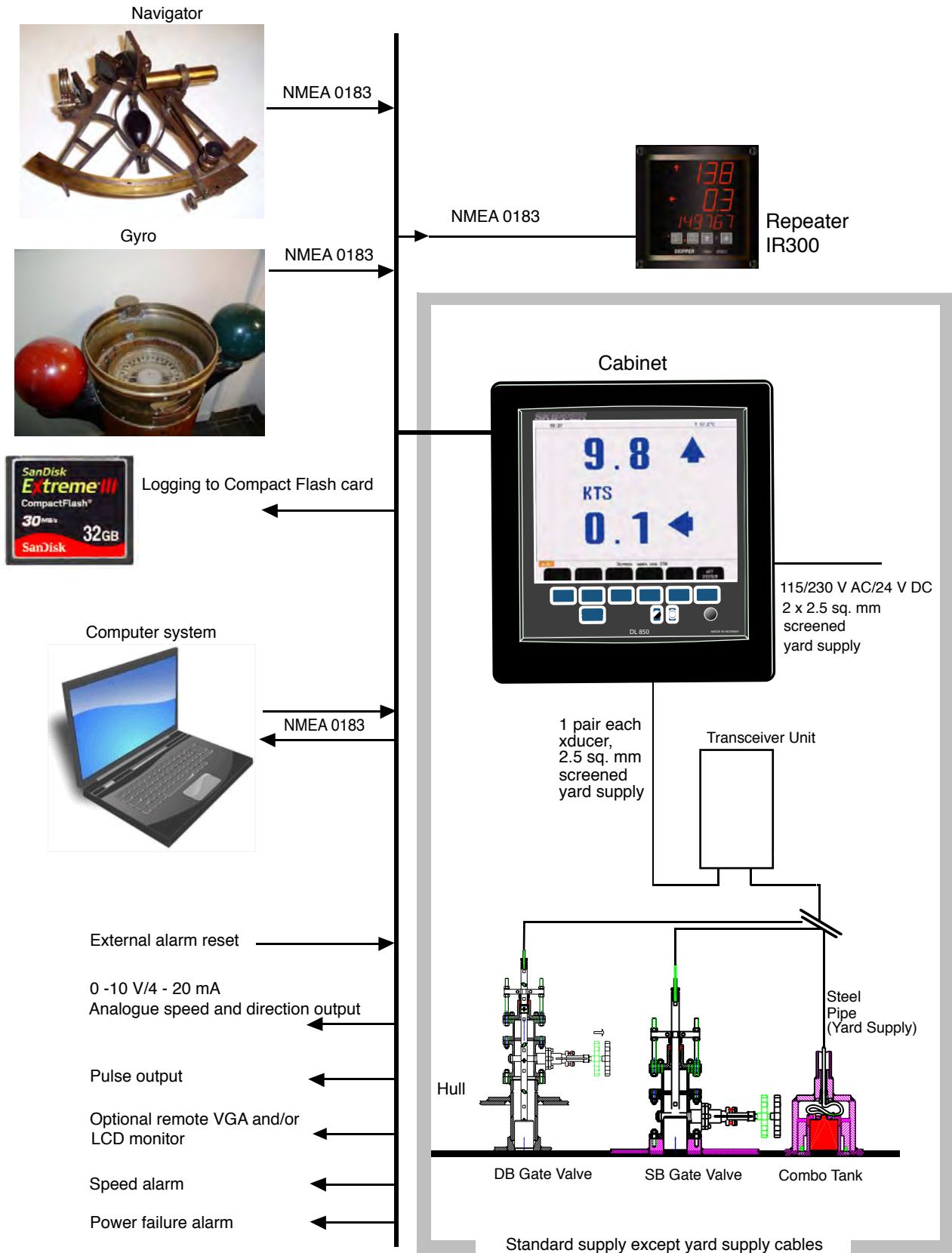

Fig. 1.2 System Diagram

2. Operation

When the installation is complete, and power is connected to the operator unit, the system is switched on/off by a power switch inside the cabinet. The unit can also be switched off by pressing the SYSTEM Off softkey button.

Note: The unit is still energized. Do not perform any connections before switching off the mains on the terminal PCB inside the cabinet.

Parameter entry

The fixed function buttons and the softkey buttons along with the rotating encoder, facilitates entry of parameters and other data. The following flowchart illustrates the procedure for changing settings. The various screens are shown in detail in the operation section.

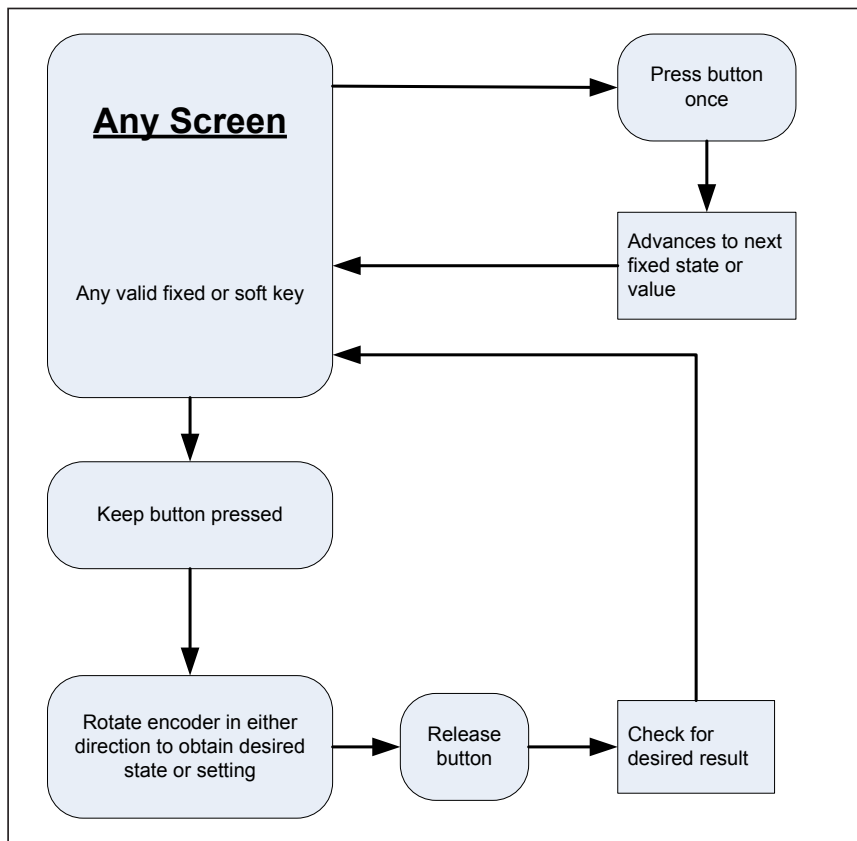

Fig. 2.1 Setting and Parameter Entry Flowchart

Example of parameter entry

Suppose you want to enter a value of 15 knots for the high speed alarm. Press the SPD ALARM▲ softkey in screen pilot, menu 1, and keep it pressed while you turn the encoder until you reach 15 knots. Release the encoder and release the SPD ALARM▲ softkey.

Primary Screens

Each of the operation screens contains a graphic picture and one or more menu sets configured on the 6 softkey buttons. The three first screens are covering the primary functions. Manoeuvring within these screens are easily done by pressing the SCREEN SELECT button.

The various screens can also be selected by keeping the SCREEN SELECT button pressed and rotating the encoder in either direction. Turning the encoder clockwise cycle the screens as shown in figure below, and counter clockwise rotation cycles the screens in the opposite direction.

The screen layouts are outlined in the following pages. The various menus and softkey functions are described with each screen.

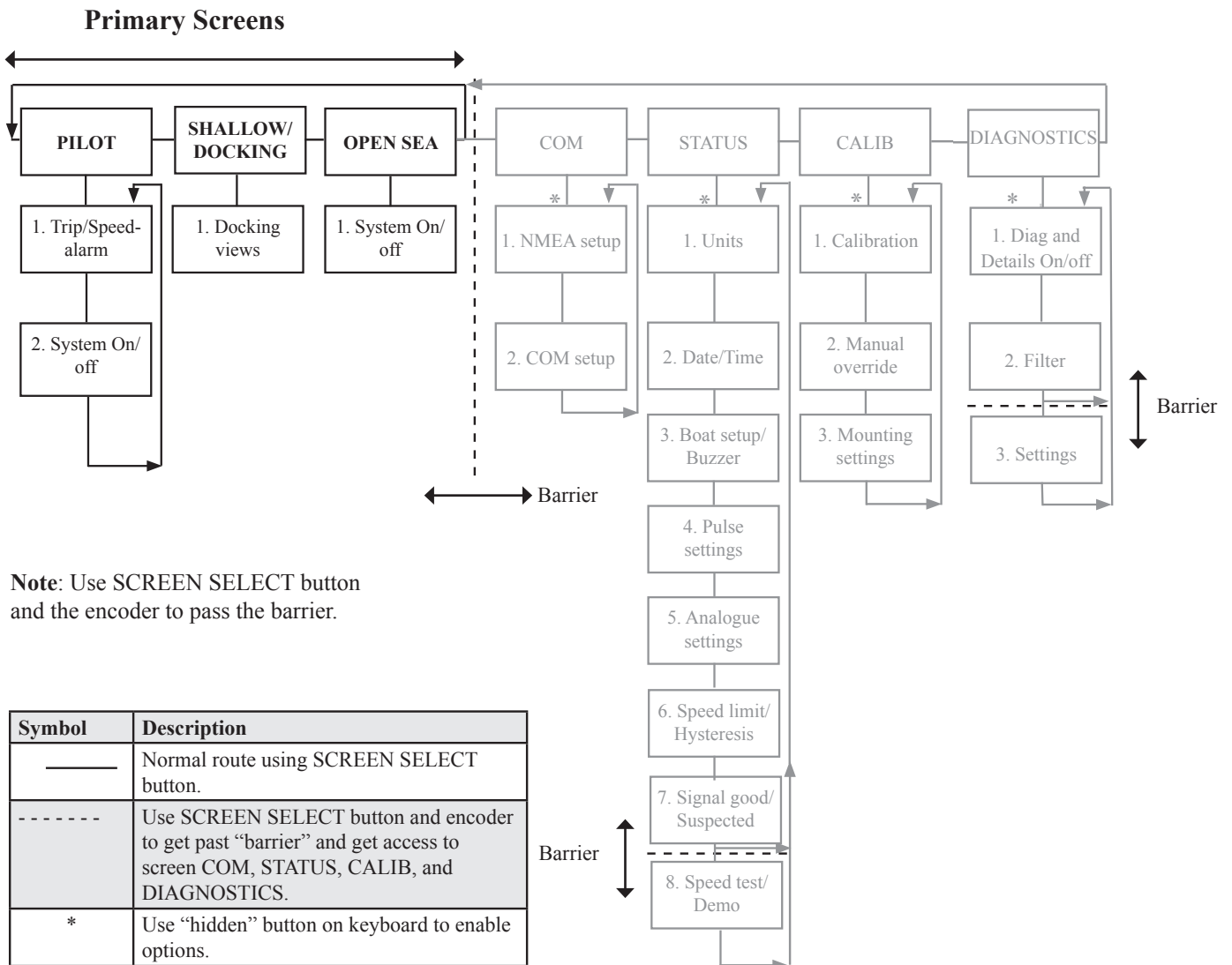

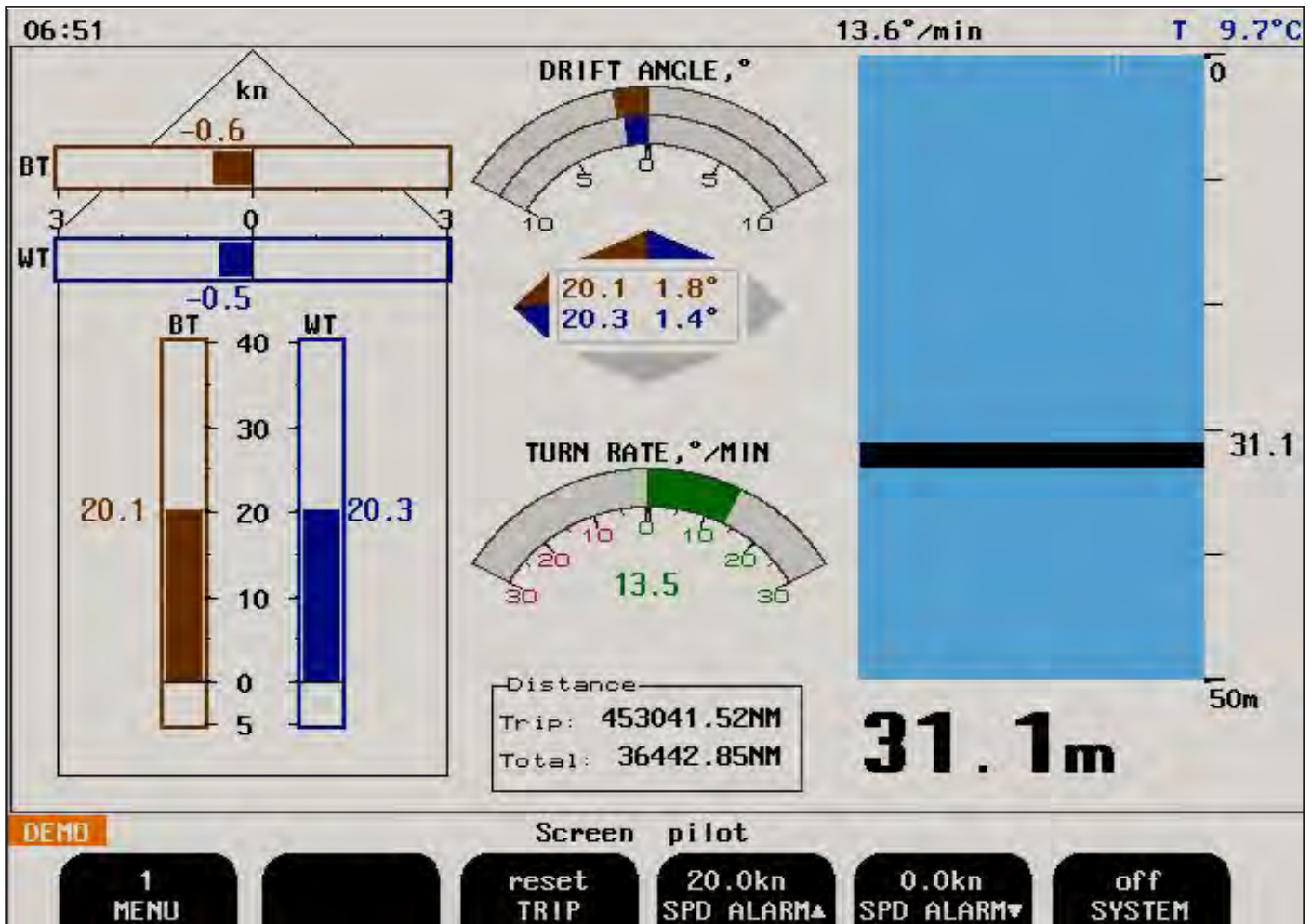

The various softkey menus are selected by pressing repeatedly the MENU button on the left side of the softkey menu. The number on the button indicates present active menu.

- “Brown” (BT, Bottom Track) is speed over ground .
- “Blue” (WT, Water Track) is speed through water.
- Drift angle is the angle between the longitudinal axis and resultant speed vector.

Screen pilot, Menu 1, trip/speed alarm.

Softkey	Name	Range/value	Default value	Description	Activate with hidden button
1	MENU	1 - 2	1	Menu 1 is selected.	
2				Not used.	
3	TRIP	Reset		Trip distance counter reset.	
4	SPD ALARM ▲	-48.4 - 48.6 kn	20.0 kn	High speed alarm.	
5	SPD ALARM ▼	-48.6 - 48.4 kn	0.0 kn	Low speed alarm.	
6	SYSTEM	On/Off	On	Turn system off.	

Note: Echo sounder profile is disabled in some versions of the software.

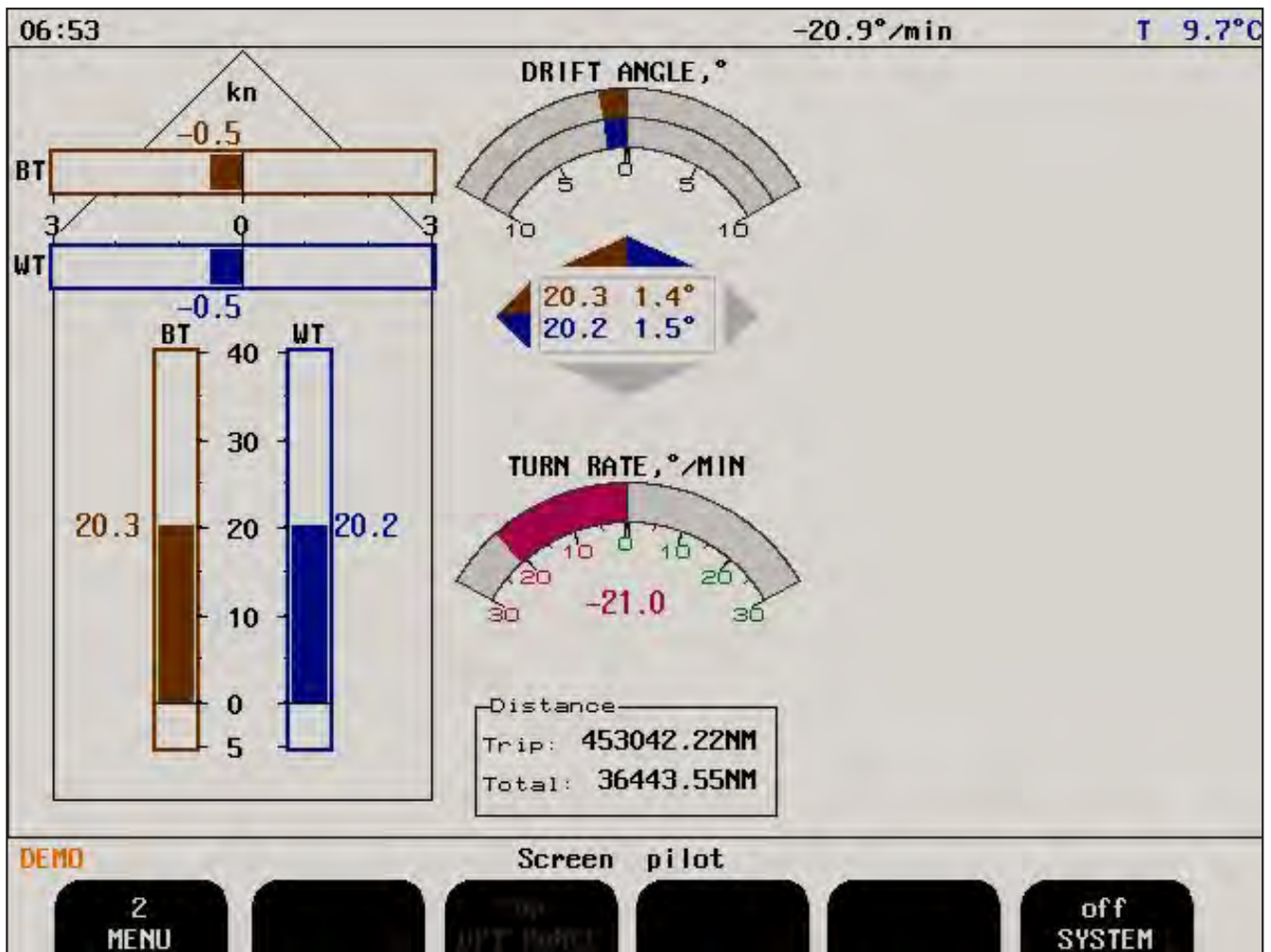

The various softkey menus are selected by pressing repeatedly the MENU button on the left side of the softkey menu. The number on the button indicates present active menu.

Screen pilot, Menu 2, system.

Softkey	Name	Range/value	Default value	Description	Activate with hidden button
1	MENU	1 - 2	2	Menu 2 is selected.	
2				Not used.	
3				Normally not used.	(See “12. Appendix 3” on page 80).
4				Not used.	
5				Not used.	
6	SYSTEM	On/Off	On	Turn system off.	

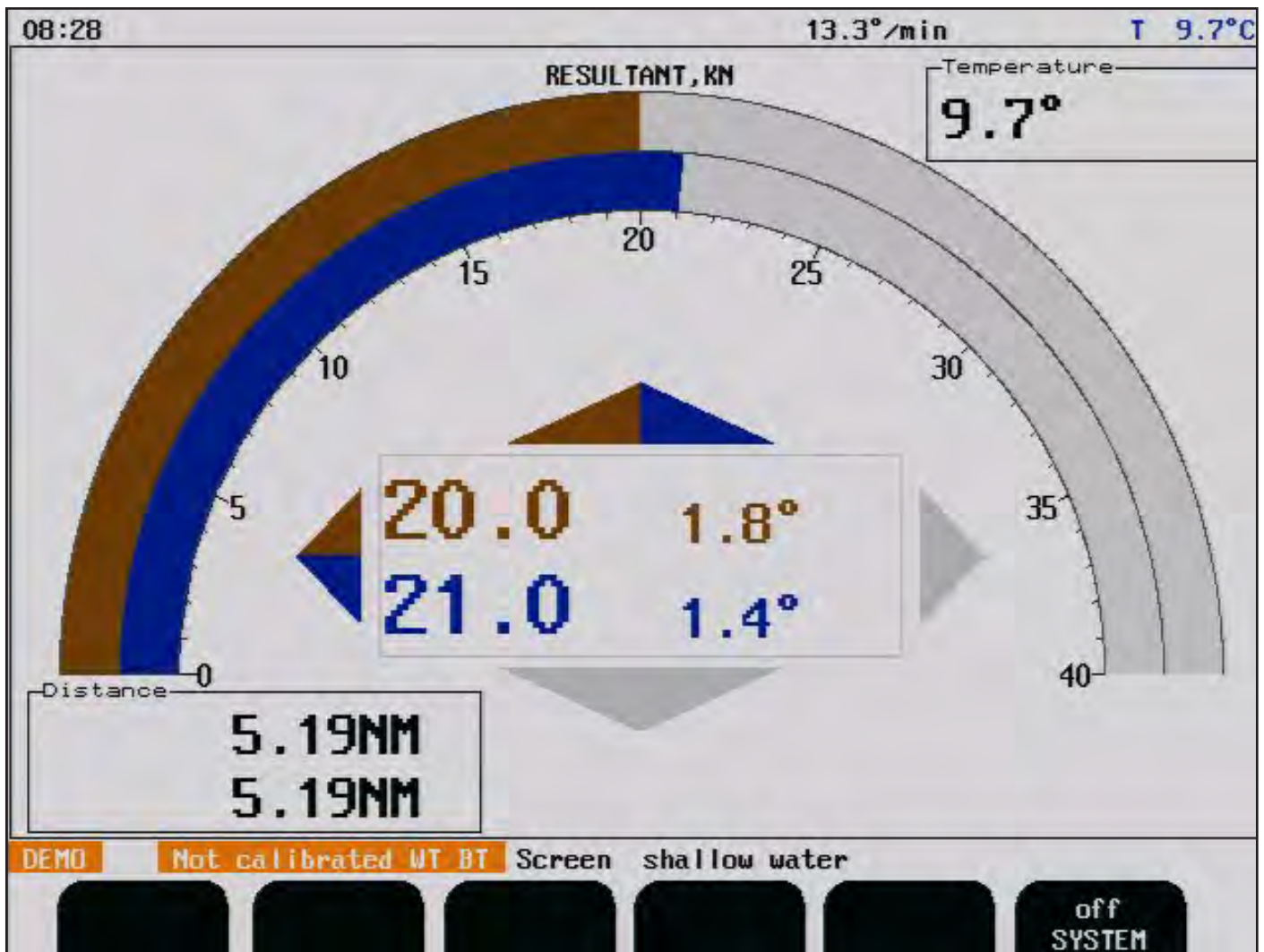

- Screen description “blue” shows resultant water speed (speed through water) and direction.
- Screen description “brown” shows resultant SOG (speed over ground) and direction. (Note: Value should be close to GPS value).
- Temperature is temperature in water.

Screen shallow water, (only in non docking version).

Softkey	Name	Range/value	Default value	Description	Activate with hidden button
1				Not used.	
2				Not used.	
3				Not used.	
4				Not used.	
5				Not used.	
6	SYSTEM	On/Off	On	Turn system off.	

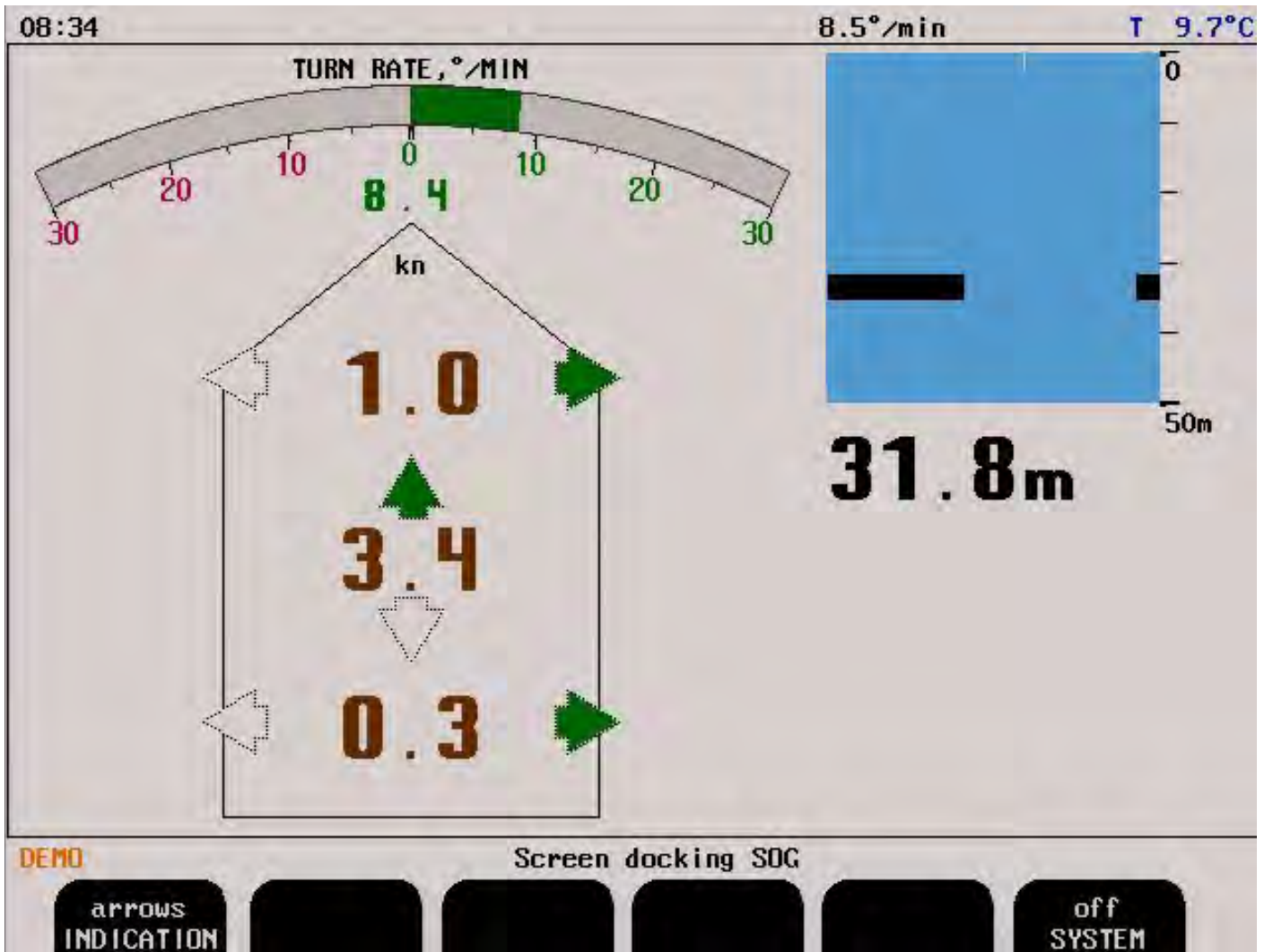

If bottom track is present, the docking screen will show measured longitudinal and transversal speed over ground (SOG) at fore and calculated speed at stern point. Speed indication may either be presented by values and arrows, or values and bars for directions.

Screen docking, arrow view (only in docking version).

Softkey	Name	Range/value	Default value	Description	Activate with hidden button
1	INDICATION	Arrows/bar graphs	Arrows	Arrow indication is selected.	
2				Not used.	
3				Not used.	
4				Not used.	
5				Not used.	
6	SYSTEM	On/Off	On	Turn system off.	

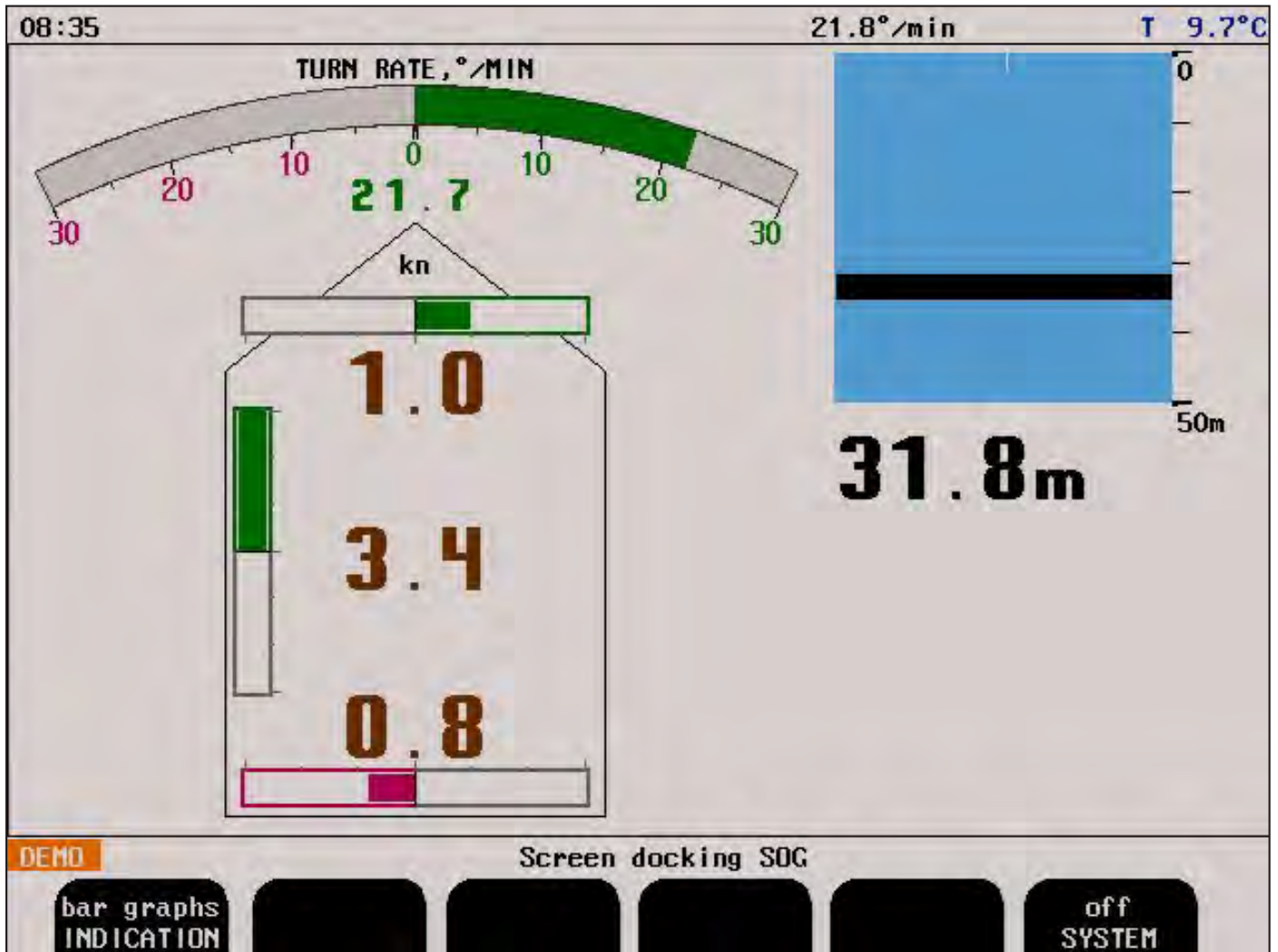

The screen above shows the result if ROT (Rate Of Turn) information is not available.

Screen docking, bar graph view (only in docking version).

Sofkey	Name	Range/value	Default value	Description	Activate with hidden button
1	INDICATION	Arrows/bar graphs	Bar graphs	Bar graph indication is selected.	
2				Not used.	
3				Not used.	
4				Not used.	
5				Not used.	
6	SYSTEM	On/Off	On	Turn system off.	

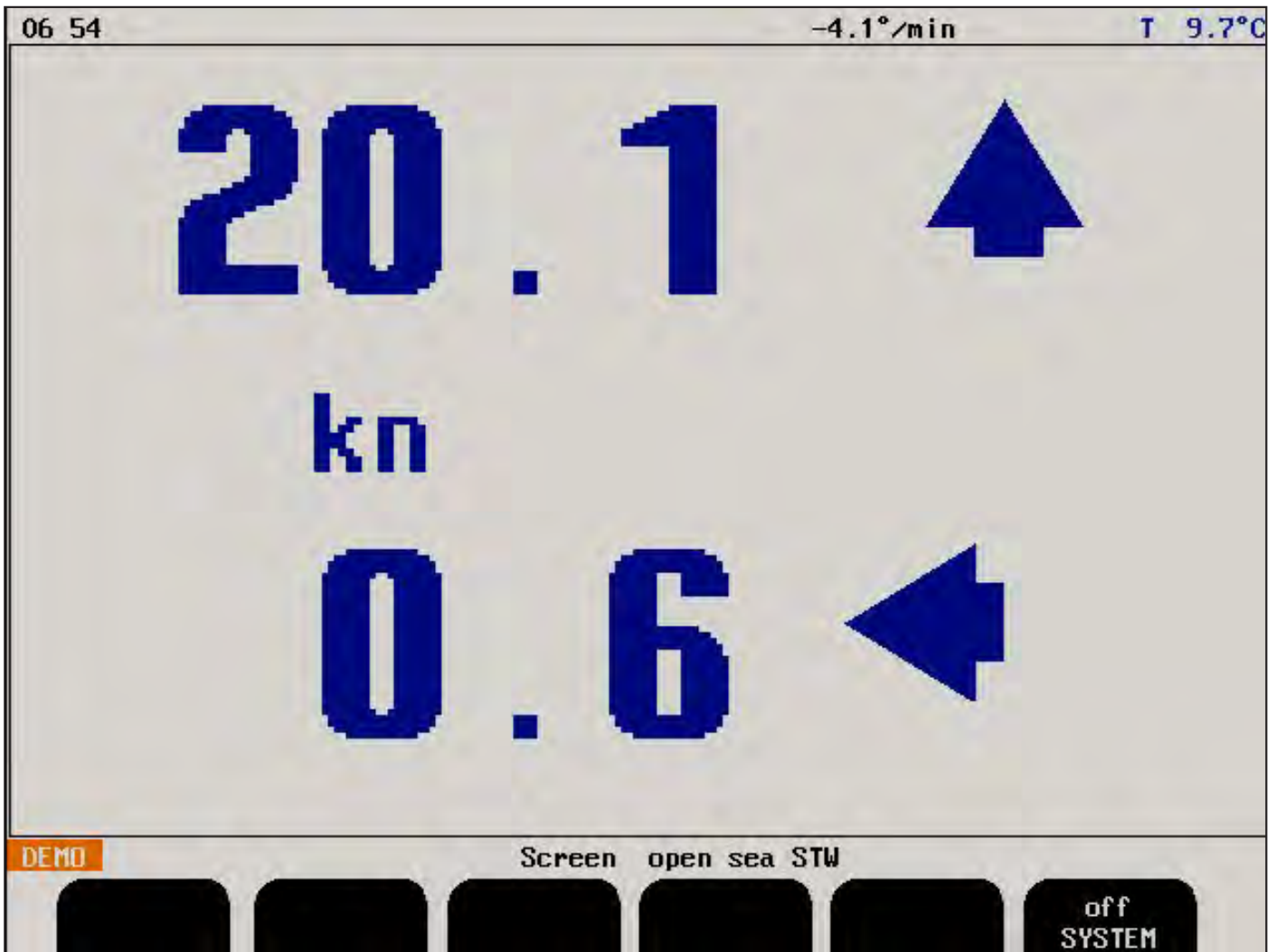

Screen open sea, system.

Softkey	Name	Range/value	Default value	Description	Activate with hidden button
1				Not used.	
2				Not used.	
3				Not used.	
4				Not used.	
5				Not used.	
6	SYSTEM	On/Off	On	Turn system off.	

Note: This screen shows speed through water only.

Setup and Function Control Screens

Each of the operation screens contains a graphic picture and one or more menu sets configured on the 6 softkey buttons. Manoeuvre to the setup and function control screens by keeping the screen select button pressed and rotating the encoder in either direction. Turning the encoder clockwise cycle the screens as shown in figure below, and counter clockwise rotation cycles the screens in the opposite direction.

The screen layouts are outlined in the following pages. The various menus and softkey functions are described with each screen.

Setup and Function Control Screens

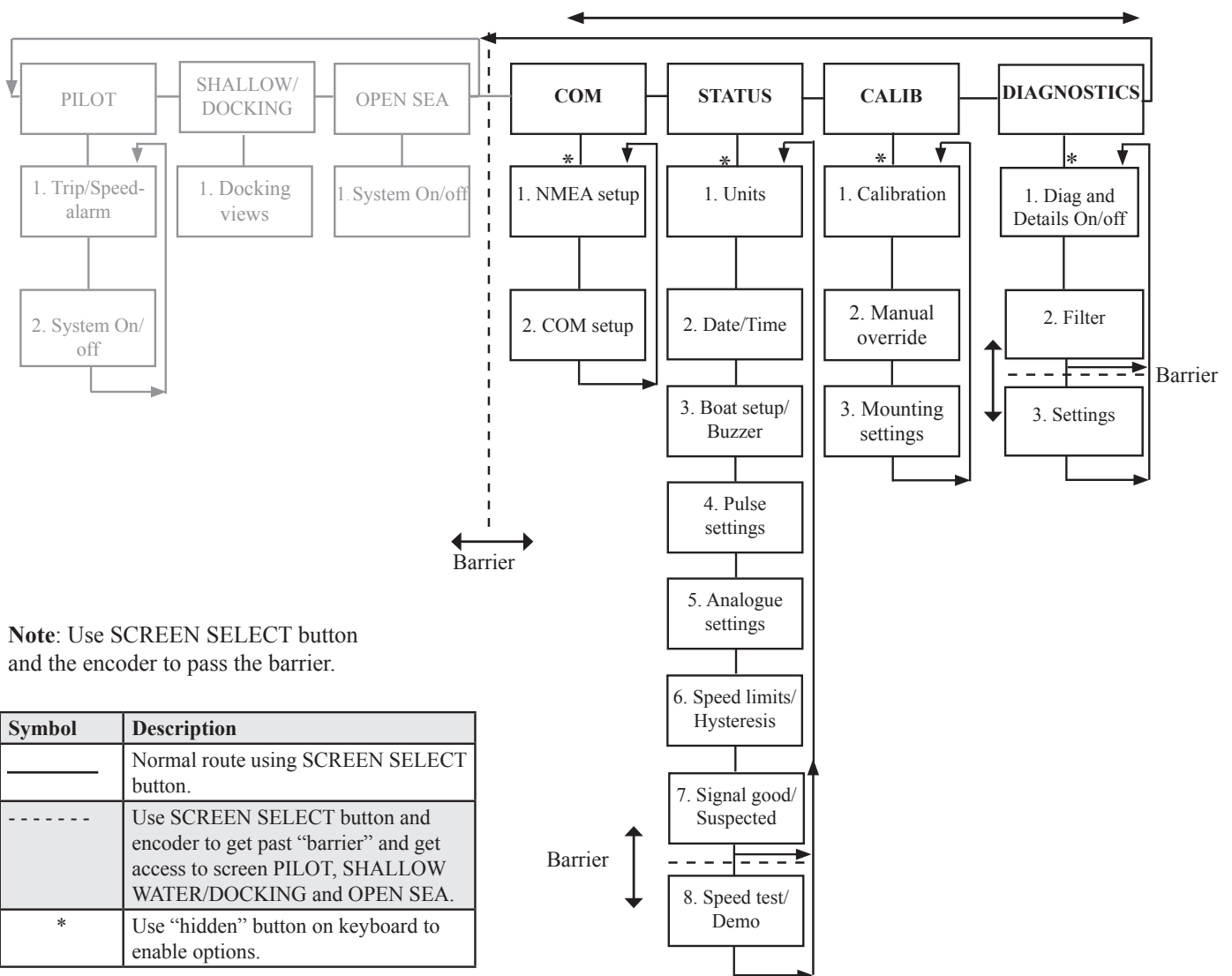

Note: Use SCREEN SELECT button and the encoder to pass the barrier.

07 05
T 21.6°C

NMEA sentences received, COM1	NMEA COM ports info		
	COM 1	COM 2	
\$UDVHW, , , , , 0.95, N, 1.76, K*52	Base addr	2e8h	3e8h
\$UDVBW, -0.66, 0.68, A, -0.37, 1.15, A, , U, , U*5E	IRQ	9	5
\$UDVHW, , , , , 0.97, N, 1.80, K*59	BAUD	4800	4800
\$UDVBW, -0.66, 0.70, A, -0.35, 1.15, A, , U, , U*55	DATA	None, 8, 1	None, 8, 1
\$UDVHW, , , , , 0.93, N, 1.73, K*51	Input XJ402	A=1, B=2	A=6, B=7
\$UDVBW, -0.64, 0.68, A, -0.35, 1.15, A, , U, , U*5E	Rx status	0'k	No signal
\$UDVHW, , , , , 0.91, N, 1.69, K*58	Data err	0	0
\$UDVBW, -0.62, 0.66, A, -0.35, 1.17, A, , U, , U*54	Overrun err	0	0
\$UDVHW, , , , , 0.91, N, 1.69, K*58	Output XJ402	A=4, B=5	A=8, B=9
\$UDVBW, -0.64, 0.66, A, -0.35, 1.15, A, , U, , U*50	DPT	off	off
\$UDVHW, , , , , 0.91, N, 1.69, K*58	DBT	off	off
\$UDVBW, -0.64, 0.64, A, -0.33, 1.13, A, , U, , U*52	DBK	off	off
\$UDVHW, , , , , 0.93, N, 1.73, K*51	VTG	off	off
\$UDVBW, -0.64, 0.68, A, -0.33, 1.15, A, , U, , U*58	VHW	on	on
	VLW	off	off
	VLW IEC07	off	off
	VBW	on	on
	MTW	off	off
	ALR	off	off
	STA	off	off
		-0.6kn	0.7kn
		-0.3kn	1.2kn
			131.9°
			104.6°

Not calibrated WT BT Screen com

1
MENU

1
COM

DPT
MESSAGE

off
OUTPUT

input
DISPLAY

Note: The displayed messages corresponds to currently selected port.

Screen com, Menu 1, NMEA setup.

Softkey	Name	Range/value	Default value	Description	Activate with hidden button
1	MENU	1-2	1	Menu 1 is selected.	
2				Not used.	
3	COM	1-2	1	Select COM port. The ports can be configured to give different messages on the different ports.	
4	MESSAGE	DPT, DBT, DBK, VTG, VHW, VLW, VLW IEC07, VBW, MTW, ALR, STA		NMEA message selector. Each message may be controlled individually by softkey 5. (Note: See "NMEA Setup" on page 48 .)	
5	OUTPUT	On/off	See fig above.	Setting for the message in softkey 4. Note: To configure the serial output of the system, go through all the messages by pressing softkey 4 and set on/off value with softkey 5 to disable/enable a message as required.	Yes (1 beep)
6	DISPLAY	Output/input/off	Input	Selects the information (received from the external source or transmitted by the DL850) to be displayed on the screen. Output: Signals transmitted from DL850. Input: Signals received from external source. Off: No signals displayed on screen.	

07 06
T 21.6°C

NMEA sentences received, COM1		NMEA COM ports info	
		COM 1	COM 2
\$UDVHW,,,,,1.11,N,2.05,K*58J		Base addr	2e8h 3e8h
\$UDVBW,-0.78,0.78,A,-0.33,1.01,A,,U,,V*51		IRQ	9 5
\$UDVHW,,,,,1.11,N,2.05,K*58J		BAUD	4800 4800
\$UDVBW,-0.78,0.78,A,-0.33,0.99,A,,U,,V*51		DATA	None,8,1 None,8,1
\$UDVHW,,,,,1.11,N,2.05,K*58J		Input XJ402	A=1,B=2 A=6,B=7
\$UDVBW,-0.78,0.80,A,-0.31,0.97,A,,U,,V*5A		Rx status	0'k No signal
\$UDVHW,,,,,1.11,N,2.05,K*58J		Data err	0 0
\$UDVBW,-0.78,0.78,A,-0.33,0.97,A,,U,,V*5F		Overrun err	0 0
\$UDVHW,,,,,1.11,N,2.05,K*58J		Output XJ402	A=4,B=5 A=8,B=9
\$UDVBW,-0.78,0.78,A,-0.33,0.97,A,,U,,V*5F		DPT	off off
\$UDVHW,,,,,1.11,N,2.05,K*58J		DBT	off off
\$UDVBW,-0.78,0.78,A,-0.33,0.99,A,,U,,V*51		DBK	off off
\$UDVHW,,,,,1.09,N,2.02,K*56J		UTC	off off
\$UDVBW,-0.78,0.76,A,-0.33,0.97,A,,U,,V*51		VHW	on on
\$UDVHW,,,,,1.11,N,2.05,K*58J		VLW	off off
\$UDVBW,-0.78,0.78,A,-0.33,0.95,A,,U,,V*5D		VLW IEC07	off off
		VBW	on on
		MTW	off off
		ALR	off off
		STA	off off
			-0.8kn 0.8kn 135.4°
			-0.3kn 1.0kn 109.4°

Not calibrated WT BT Screen com

2 MENU	1 COM	4800 BAUD	None,8,1 DATA	reset COM ERROR
-----------	----------	--------------	------------------	--------------------

Screen com, Menu 2, NMEA com setup.

Softkey	Name	Range/value	Default value	Description	Activate with hidden button
1	MENU	1-2	2	Menu 2 is selected.	
2				Not used.	
3	COM	1-2	1	Choose COM port.	
4	BAUD	1200, 2400, 4800, 9600, 19200, 38400, 57600, 115200	4800	Baud rate for chosen COM port.	Yes (1 beep)
5	DATA	None-7-1, Even-7-1, Odd-7-1 None-7-2, Even-7-2, Odd-7-2 None-8-1, Even-8-1, Odd-8-1 None-8-2, Even-8-2, Odd-8-2	None, 8, 1	Data format for chosen COM port. Parity, data bits, stop bits.	Yes (1 beep)
6	COM ERROR	Reset		Reset field for COM errors. The program memorizes the latest occurred NMEA input error for further analysis. By using this softkey, it is possible to reset the error.	

Note: Baud rate and data settings apply to both input and output for selected COM port. Not recommended to use BAUD values above 38400 on terminals boards earlier than version E.

14 37
T 22.2°C

NMEA sentences received, COM1	NMEA COM ports info	
\$WIMWD,93.2,T,92.8,M,12.3,N,,*02	COM 1	COM 2
\$SHEHDT,123.40,T*1B	Base addr	2e8h 3e8h
\$SHEHDT,123.40,T*FF	IRQ	9 5
\$SHEHDT,123.40,T	BAUD	4800 4800
\$TIHDT,123.40,T*0B	DATA	None,8,1 None,8,1
\$SHEROT,10.40,A*2E	Input XJ402	A=1,B=2 A=6,B=7
\$SHEROT,10.40,V*39	Rx status	0'k No signal
\$WIMWD,93.2,T,92.8,M,12.3,N,,*02	Data err	0 0
\$WIMWD,93.2,T,92.8,M,12.3,N,,*02	Overrun err	0 0
\$SHEHDT,123.40,T*1B	Output XJ402	A=4,B=5 A=8,B=9
\$SHEHDT,123.40,T*FF	DPT	off off
\$SHEHDT,123.40,T	DBT	off off
\$TIHDT,123.40,T*0B	DBK	off off
\$SHEROT,10.40,A*2E	UTC	off off
\$SHEROT,10.40,V*39	VHW	on on
\$WIMWD,93.2,T,92.8,M,12.3,N,,*02	VLW	off off
\$WIMWD,93.2,T,92.8,M,12.3,N,,*02	VLW IEC07	off off
\$SHEHDT,123.40,T*1B	VBW	on on
\$SHEHDT,123.40,T*FF	MTW	off off
\$SHEHDT,123.40,T	ALR	off off
\$TIHDT,123.40,T*0B	STA	off off
\$SHEROT,10.40,A*2E		0.2kn 0.1kn 19.5°
		0.2kn 0.1kn 14.5°

DEMO Screen com

1 MENU	1 COM	DPT MESSAGE	off OUTPUT	input DISPLAY
-----------	----------	----------------	---------------	------------------

The following examples show how the system responds to errors in the NMEA input formats. Formats in red are rejected. See [“NMEA Setup” on page 48](#) for more informations about accepted formats.

Input NMEA message	Description	Format status
\$TIHDT,123.40,T*1B	Correct, accepted format with checksum.	Accepted.
\$SHEROT,10.40,A*2E	Correct, accepted format with checksum.	Accepted.
\$SHEROT,10.40,V*39	Correct, accepted format with checksum but invalid status symbol.	Rejected.
\$SHEHDT,123.4,T	Correct, accepted format without checksum.	Rejected.
\$SHEHDT,123.4,T*FF	Correct, accepted format with wrong checksum.	Rejected.
\$WIMWD,93.2,T,92.8,M,12.3,N,,*02	Correct, not recognised format.	Rejected.

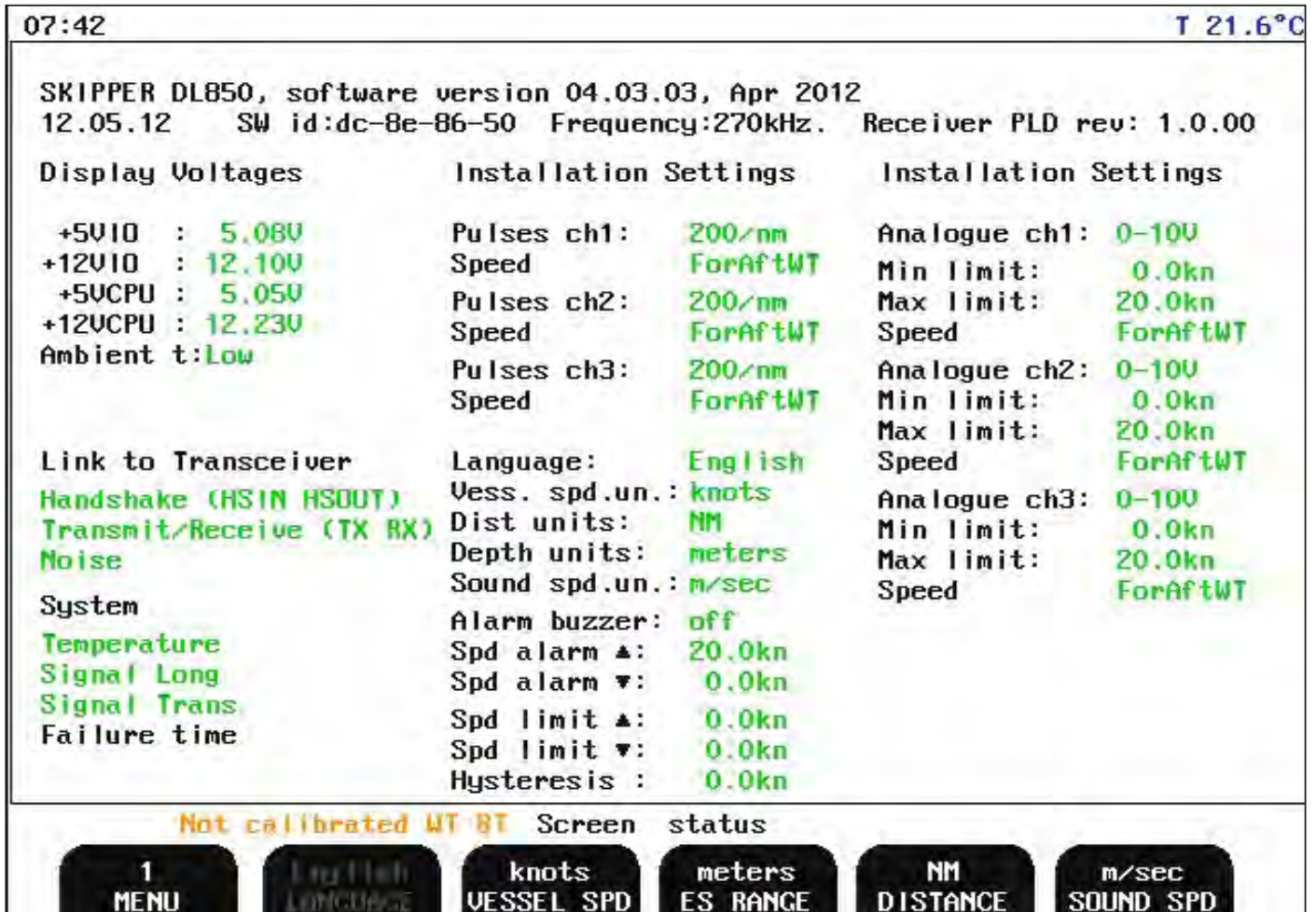

The status screen contains information that will facilitate analysis and correction of several problems. All installation settings are displayed on this screen. See section for trouble-shooting for more information about typical status screen content.

Screen status, Menu 1, units.

Softkey	Name	Value/range	Default value	Description	Activate with hidden button
1	MENU	1 - 8	1	Menu 1 is selected.	
2	LANGUAGE	English		Not active.	
3	VESSEL SPD	knots, km/h, mi/h, m/sec	knots	Select speed unit.	
4	ES RANGE	meters, feet, fathoms, braccias	meters	Select depth unit.	
5	DISTANCE	NM, km, mi	NM	Select distance unit.	
6	SOUND SPD	m/sec, ft/sec, knots, km/h, mi/h	m/sec	Select sound speed unit.	

Note: See [“System Adaption” on page 48](#) for more information.

System:

Text in red indicates a problem with the system, text in orange indicates a potential but non critical problem. In both cases, run self diagnostics in the diagnostic screen to find the source of the problem. **Note:** More about the status information in section [“Typical Status Screen Contents” on page 59](#).

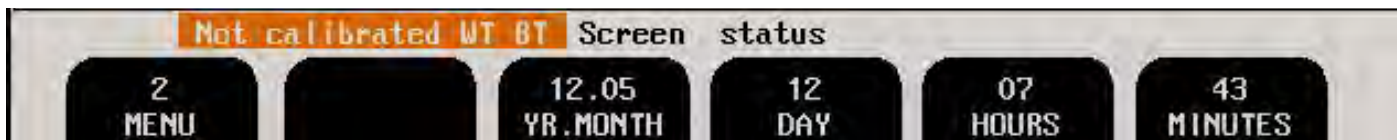

Screen status, Menu 2, date/time.

Softkey	Name	Range/value	Default value	Description	Activate with hidden button
1	MENU	1 - 8	2	Menu 2 is selected.	
2				Not used.	
3	YR.MONTH	00.01 - 31.12		Year and month setting.	
4	DAY	01 - 31		Day setting.	
5	HOURS	00 - 23		Hours setting.	
6	MINUTES	00 - 59		Minutes setting.	

Note: If time and date information are provided on the NMEA input, these will have highest priority and time and date softkeys are disabled (dimmed).



Screen status, Menu 3, boat setup/buzzer.

Softkey	Name	Value/range	Default value	Description	Active with hidden button
1	MENU	1 - 8	3	Menu 3 is selected.	
2	SHIP LEN	0.00 - 500.0 m	150.0 m	Overall ship length (used for docking mode).	Yes (1 beep)
3	BOW<->SENS	0.00 - 500.0 m	5.00 m	Distance from bow to sensor (used for docking mode).	Yes (1 beep)
4				Not used.	
5	DRAUGHT	0.00 - 99.9 m	0.00 m	Echo sounder draught.	Yes (1 beep)
6	BUZZER	On/Off	Off	Enable or disable the alarm buzzer.	Yes (1 beep)

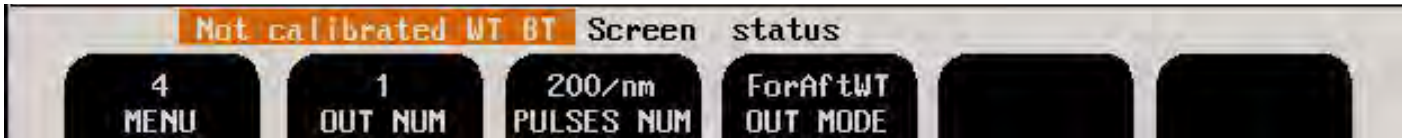

Screen status, Menu 4, pulse settings.

Softkey	Name	Range/value	Default value	Description	Active with hidden button
1	MENU	1 - 8	4	Menu 4 is selected.	
2	OUT NUM	1 - 3	1	Pulse output channel to be configured by softkey 3 and 4 (Ch 1, Ch 2 and Ch 3). Note: If speed limit is activated, only OUT NUM 2 and 3 are available.	
3	PULSES NUM	10/100/200/400/1000/nm	200/nm	Number of pulses per nautical mile at selected channel (softkey 2). Note: 1000/nm only on Ch 3 (OUT NUM3).	Yes (1 beep)
4	OUT MODE	ForAftWT, LateralWT, ResultWT, ForAftBT, LateralBT, ResultBT.	ForAftWT	Type of speed value to be output at selected channel.	Yes (1 beep)
5				Not used.	
6				Not used.	

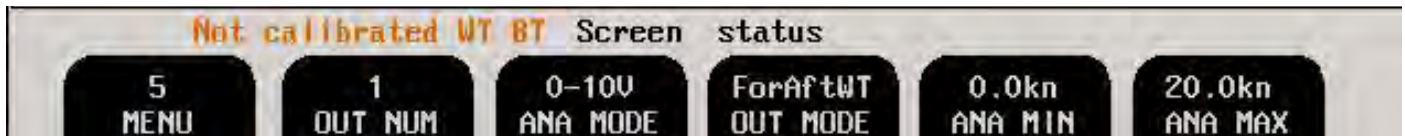

Screen status, Menu 5, analogue settings.

Softkey	Name	Range/value	Default value	Description	Activate with hidden button
1	MENU	1 - 8	5	Menu 5 is selected.	
2	OUT NUM	1 - 3	1	Analogue output channel to be configured by softkey 3 - 6 (Ch1, Ch 2, Ch 3).	
3	ANA MODE	0 - 10 V 4 - 20 mA	0 - 10 V	Select output mode for this channel (softkey 2).	Yes (1 beep)
4	OUT MODE	ForAftWT, LateralWT, ResultWT, ForAftBT, LateralBT, ResultBT.	ForAftWT	Type of speed value to be output at selected channel (softkey 2).	Yes (1 beep)
5	ANA MIN	-48.6 - 48.4 kn	0.0 kn	Speed value, corresponding to minimum analogue value at selected channel. Corresponds to 0 V, 4 mA.	Yes (1 beep)
6	ANA MAX	-48.4 - 48.6 kn	20.0 kn	Speed value, corresponding to maximum analogue value at selected channel. Corresponds to 10 V, 20 mA.	Yes (1 beep)

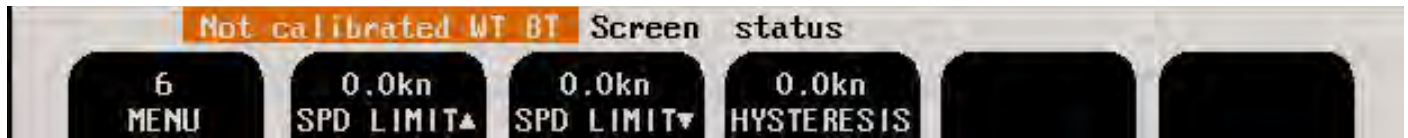

Screen status, Menu 6, speed limits and hysteresis

Softkey	Name	Range/value	Default value	Description	Activate with hidden button
1	MENU	1 -8	6		
2	SPD LIMIT▲	-48.6 - 48.6 kn	0.0 kn	High speed limit value.	Yes (1 beep)
3	SPD LIMIT▼	-48.6 - 48.6 kn	0.0 kn	Low speed limit value.	Yes (1 beep)
4	HYSTERESIS	0.0 - 2.0 kn	0.0 kn	Difference between high and low limit.	Yes (1 beep)
5	Not used			Not used	
6	Not used			Not used	

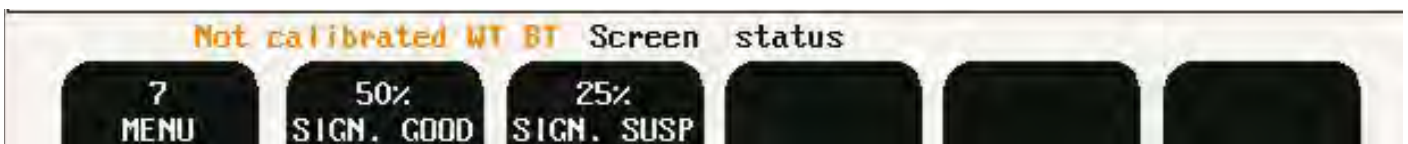

Screen status, Menu 7, signal good/signal suspected

Softkey	Name	Range/value	Default value	Description	Activate with hidden button
1	MENU	1 -8	7		
2	SIGN. GOOD	6- 90 %	50 %	Min. sample % to be qualified as good.	Yes (1 beep)
3	SIGN. SUSP(ECTED)	5 - 89 %	25 %	Min. sample % to be qualified as suspected.	Yes (1 beep)
4	Not used			Not used	
5	Not used			Not used	
6	Not used			Not used	

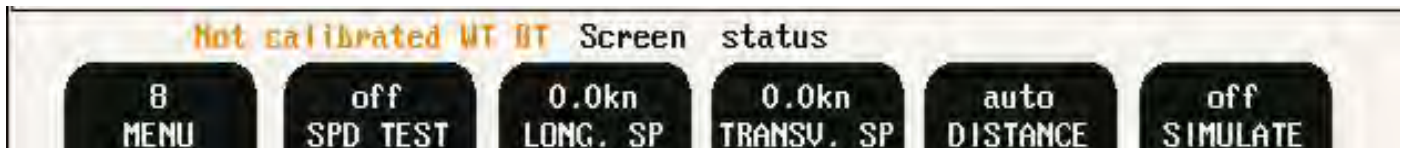

Screen status, Menu 8, speed test/demo (simulate).

Functions described below can be used during commissioning period to test different DL850 outputs with constant, user adjustable speed values.

Note: When the test mode is activated, this will be indicated by flashing “TEST” label in the lower left part of the screen. Simulator mode will be indicated with the label “DEMO”.

Note: Use the SCREEN SELECT softkey and the encoder to get access to screen status menu 8.

Softkey	Name	Range/value	Default value	Description	Activate with hidden button
1	MENU	1 -8	8	Note: Press MENU softkey and turn encoder to select menu 8.	
2	SPD TEST	On/Off	Off	Toggling test mode.	Yes (1 beep)
3	LONG. SP	-40.0 - 40.0 kn	0.0 kn	Select test value for longitudinal speed.	Yes (1 beep)
4	TRANSV. SP	-5.0 - 5.0 kn	0.0 kn	Select test value for transversal speed.	Yes (1 beep)
5	DISTANCE	Auto, 0.00 - 99946.00 NM	Auto	Select test value for distance.	Yes (1 beep)
6	SIMULATE	On/Off	Off	Simulator on/off.	

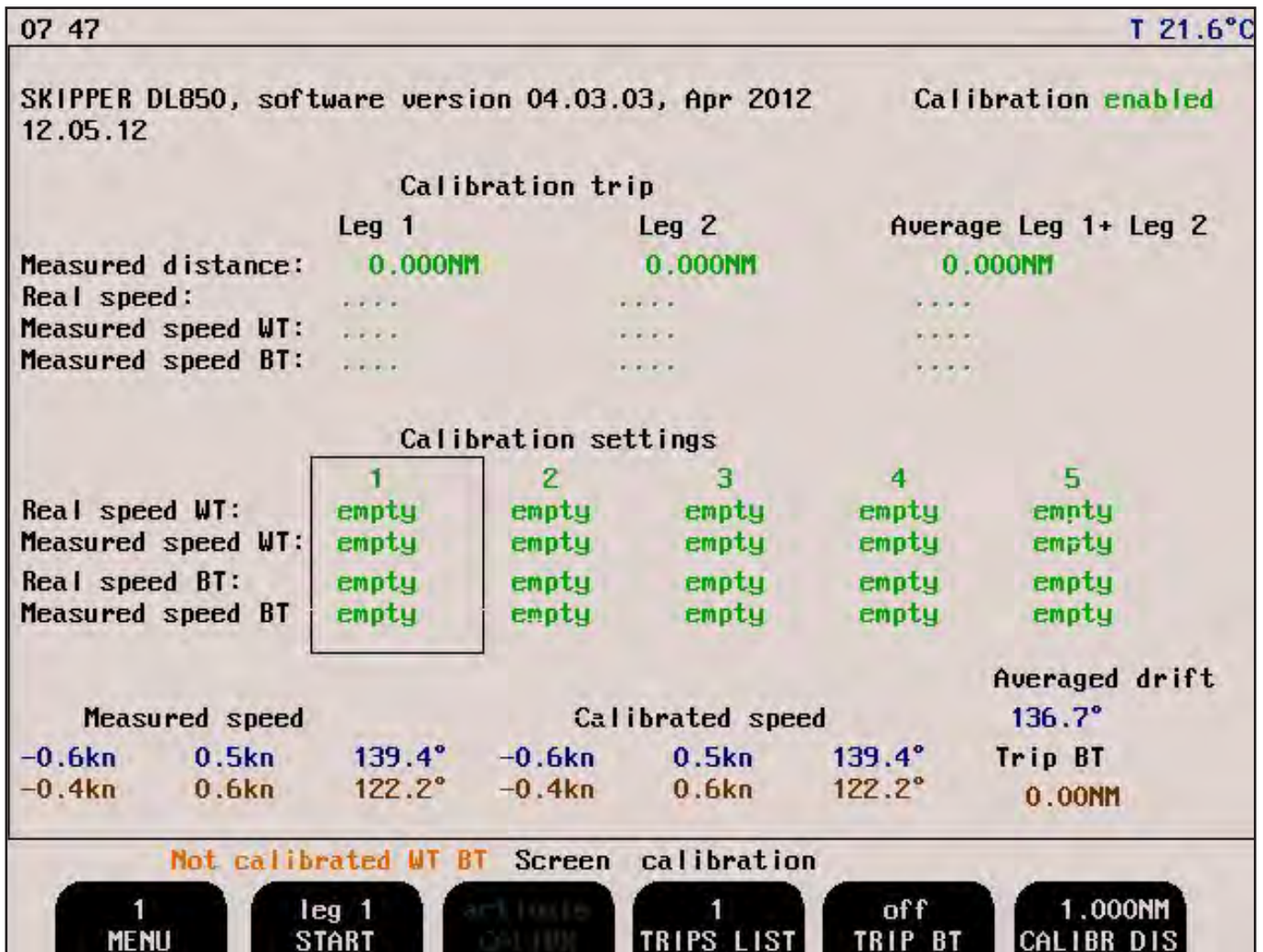

The various softkey menus are selected by pressing repeatedly the MENU button on the left side of the softkey menu. The number on the button indicates present active menu.

Note: If the system is not calibrated, a warning "Not calibrated WT BT" will flash on the lower left part of the screen. For calibration, see: ["6. Calibration procedure" on page 51.](#)

Screen calibration, Menu 1, calibration.

Softkey	Name	Range/value	Default value	Description	Activate with hidden button
1	MENU	1 - 3	1	Menu 1 is selected.	
2	START	Leg 1 start/finish Leg 2 start/finish	Leg 1	Used to start/finish test trip.	Yes (1 beep)
3	CALIBR	Activate		Used to move data, collected during test trip into calibration table. Note: Active when calibration is within limits.	
4	TRIPS LIST	1 - 5	1	Used to list between different test trip data sets. Only one test trip is displayed on the screen at a time.	
5	TRIP BT	On/Off	Off	Trip counter for bottom track (BT) on/off.	
6	CALIBR DIS	0.054 - 5.400 NM	1.000 NM	Used to adjust length of the test leg.	

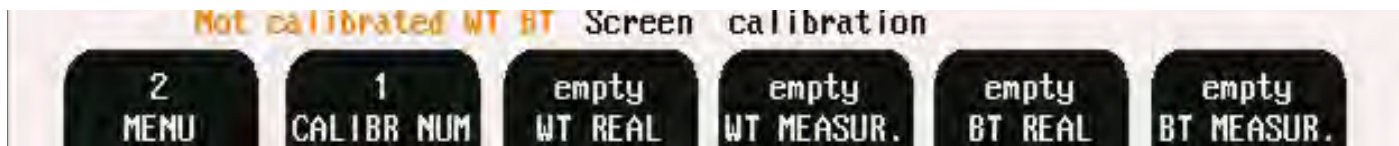

Screen calibration, Menu 2, manual override.

Softkey	Name	Range/value	Default value	Description	Activate with hidden button
1	MENU	1 - 3	2	Menu 2 is selected.	
2	CALIBR NUM	1 - 5	1	Number on the calibration data set currently available for adjustments. In the calibration table it is marked by the frame.	
3	WT REAL	0.0 - 48.6 kn	Empty	Real ship's water track speed (reference speed).	Yes (1 beep)
4	WT MEASUR.	0.0 - 48.6 kn	Empty	Water track speed, measured by the system.	Yes (1 beep)
5	BT REAL	0.0 - 48.6 kn	Empty	Real ship's bottom track speed (reference speed).	Yes (1 beep)
6	BT MEASUR.	0.0 - 48.6 kn	Empty	Bottom track speed, measured by the system.	Yes (1 beep)

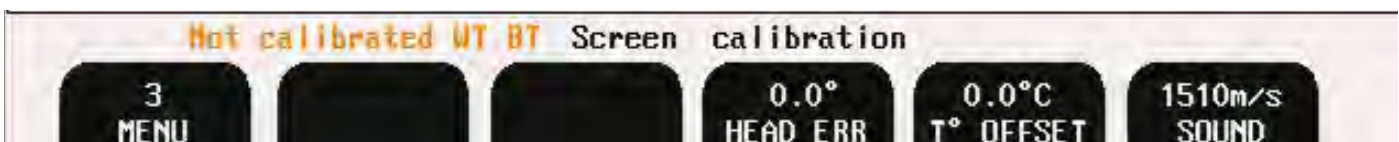

Screen calibration, Menu 3, mounting settings.

Softkey	Name	Range/value	Default value	Description	Activate with hidden button
1	MENU	1 - 3	3	Menu 3 is selected.	
2				Not used.	
3				Not used.	
4	HEAD ERR	-30.0° - 30.0°	0.0°	Installation angular error correction.	Yes (1 beep)
5	T° OFFSET	-10.0°C - 10.0°C	0.0°C	Temperature offset correction.	Yes (1 beep)
6	SOUND	1400 - 1550 m/s	1510 m/s	Speed of sound in water.	Yes (1 beep)

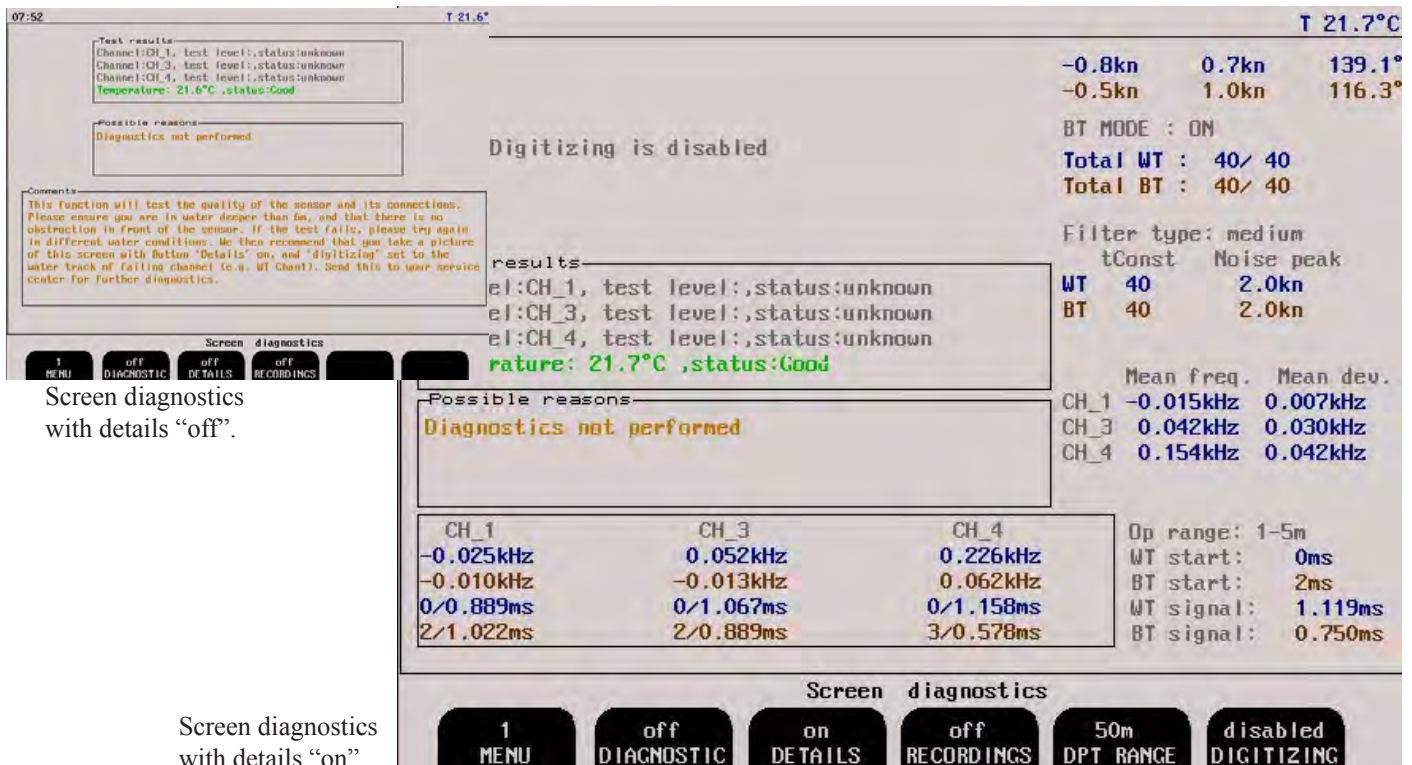

Screen diagnostics with details “off”.

Screen diagnostics with details “on”.

Screen diagnostics, Menu 1, settings.

Soft-key	Name	Range/ value	Default value	Description	Activate with hidden button
1	MENU	1 - 3	1		
2	DIAGNOSTIC	On/off	Off	Start self diagnostics procedure, The results will be shown in the ‘test results’ frame, and advice based on the results, will be displayed in ‘possible reasons’. More info in section “Typical diagnostic screen contents.” on page 61. Note: Diagnostics not available in Demo/Simulate mode.	
3	DETAILS	On/Off	Off	Normal use should require only a diagnostic check to find if there are errors. If additional information is required, set DETAILS to “on, and live diagnostic information will be made available.	
4	RECORDINGS	On/Off	Off	If necessary, the user can log all relevant raw data to the Compact Flash disk. This data will be stored in an internal proprietary format that can be analysed upon request.	
5	DPT RANGE	10 - 230 m	100 m	Depth range to be used in the oscillogram window to adjust the time base of the scope, and depth of conventional echo sounder picture (when enabled).	Active when DETAILS is “on”.
6	DIGITIZING	Disabled, wt ch1, wt ch3, wt ch4, bt ch1, bt ch3, bt ch4.	Disabled	This function allows to display oscillogram in the graphical window from any channel in both water track and bottom track modes. It will allow examining shape and amplitude of the returned signal in each individual channel. Note: This function delays signal processing and must be set to “Disabled” during normal operation to reduce latency of the system.	Active when DETAILS is “on”.

Important note: In case of accidental changing of some parameters, which causes serious malfunction, reset all parameters to factory defaults. To do this, it is necessary to switch power off and on again. Press the left and right softkeys in the upper row and keep them pressed until the graphic picture appears on the screen. 4 beeps are provided; signaling that master reset operation has been completed. Remember, that in this case, all previously set parameters (analogue ranges, NMEA message outputs etc.) must be repeated.



Screen diagnostics, Menu 2, filtering/averaging.

Soft-key	Name	Range/value	Default value	Description	Activate with hidden button
1	MENU	1 - 3	2	Menu 2 is selected.	
2	FILTER	Low, Medium, High, Run. Aver	Medium	Selects speed filtering parameters. Run Aver: This is a simple running average taking the user selectable number of points and averaging these to give the output result. Low, Medium, High: These are preset values for a threshold filter.	
3	WT tCONST	1 - 155	40	Number of individual samples to be averaged in WT mode to provide better accuracy.	Yes (2 beeps)
4	WT NOIS. PK	0.2 - 3.9 kn	2.0 kn	Noise threshold referred to the calculated mean value used in water track. Note: "Dimmed" if "Run. Aver" is selected as filter setting (softkey 2).	Yes (2 beeps)
5	BT tCONST	1 - 155	40	Number of individual samples to be averaged in BT mode to provide better accuracy.	Yes (2 beeps)
6	BT NOISE. PK	0.2 - 3.9 kn	2.0 kn	Noise threshold referred to the calculated mean value used in bottom track. Note: "Dimmed" if "Run. Aver" is selected as filter setting (softkey 2).	Yes (2 beeps)



Screen diagnostics, Menu 3, BT settings.

Soft-key	Name	Range/value	Default value	Description	Activate with hidden button
1	MENU	1 - 3	3	Menu 3 is selected. Note: Press MENU softkey and use encoder to get access to menu 3.	
2	MEAN VALUE	WT/ BT	WT	Toggle between WT and BT for the information showing mean frequency and deviation for last 100 samples.	Active when DETAILS is "on" in menu 1
3				Normally not used	See "12. Appendix 3" on page 80.
4	SL BT MODE	On/off	On	Enabling/Disabling individual BT samples, which are only executed, when the operating range is 25m or lower. Can be used for trouble shooting and factory testing. Must be switched on at normal operation.	Active when AUTO BT is off.
5	AUTO BT	On/off	On	Toggle automatic bottom track. If switched on, bottom track sampling rate is automatically reduced if the present water depth is greater than bottom track operating range. If AUTO BT is switched off, bottom track function will operate continuously, but still only give BT speed indications within the range for bottom track.	Yes (2 beeps)
6				Normally not used	See "12. Appendix 3" on page 80.

Principal Functions

Doppler Log Principle

The Doppler log works on the principle of detecting Doppler frequency shifts, i.e the phenomena of a perceived frequency being dependent on the relative speed of the emitting and receiving systems.

$$\Delta f = \frac{2v}{c} f$$

Observed frequency shift Δf .

Emitted frequency f .

Measured velocity, v .

Speed of sound in water, c .

A short burst of a known frequency is emitted into the water, and the frequency of the received echoes are measured. The difference between the emitted frequency and the received frequency makes it possible to calculate the relative speed. If the reflecting body is the bottom, the measured speed will be relative to ground. By measuring the reflections from the particles in a near water layer, a relative water speed may be obtained.

Bottom Track Characteristics

DL850 will try to acquire a bottom track when the depth is between 2 and ca. 150 m, depending on the bottom conditions. In this case, both bottom track and water track data will be acquired.

Water Track Characteristics

Water relative speed is measured in the first 2.3 m of water below the transducer. Accurate water tracking will only be available in depths greater than this. If shallower than this, some element of bottom speed will effect the result.

Docking Function - Option

Docking function is a feature for navigators which have a need of the transversal speed aft the ship. Instead of installing a second sensor aft, (which will normally cause problems due to turbulence under the sensor) the movement of the ship is calculated using the forward sensor and the gyro compass's rotation signal. Provided the ROT (Rate of Turn) signals fulfil the IMO standards (IMO Resolution A.526 (13)) and the Doppler sensor is installed and operating correctly, the transversal speed aft of the ship will be calculated to the required accuracy of 0.2 kn.

The longer the vessel, the more accurate the requirement of the Doppler sensor. The accuracy of the sensor can be increased by increasing the averaging time of the system, or the size of the measurement sample (cell). The software will calculate the optimum averaging and cell size, based on the requirement spec of the system and set this as the default value. It is likely the averaging can be reduced to give a faster response as most systems have an actual performance better than the requirements. During installation, parameters for the ship length at waterline and distance between the bow and sensor must be entered into the log. These parameters are used for calculating the aft speed.

Echo sounder option

With the echo sounder (ES) option active, (see [“Screen Diagnostics, Menu 3, ES mode, SL BT mode, GPS->BT” on page 81](#)) the depth will be shown as a thick black line in the echo sounder window, just

showing the bottom contour. This depth is measured with the forward beam (tilted) and can not be used for approved navigation as approved echo sounder function.

Non-volatile Parameter Memory

The system contains memory to maintain installation and user parameters like unit of measurement, back light settings, etc. These parameters are kept in battery backed-up static RAM memory on the I/O board, and are automatically restored on power up. If the user parameters have never been set, default values are used. These values will be reset to default values when the “Master Reset” procedure is performed.

Fixed Key Functions

Screen Select

The screen select button facilitates selection of one of the 7 screen and softkey layouts. The 3 primary operation screens (Screen Pilot, Screen Docking/Shallow Water and Screen Open Sea) may be cycled by repeatedly pressing the SCREEN SELECT button. Access to the remaining 4 screens (Screen Com, Screen Status, Screen Calibration and Screen Diagnostic) is through encoder operation. The screens are cycled in an endless, bidirectional loop, e.g. turning the encoder counter-clockwise, will “open” screen 7 after screen 1.

Backlight adjustment (brightness)

Backlight may be controlled by using the appropriate button and the encoder. Press the backlight button and rotate the encoder until a satisfactory setting is obtained, then release the button. The settings are maintained in the nonvolatile memory, and the last settings are restored on power up.

Day/Night

Day/Night vision may be selected by pressing this button. These two modes differs by colour presentation, which are optimized for different ambient light conditions.

Soft Key Functions

User adjusted functions

Menu

If several menus are available, the leftmost softkey is always used for selecting the desired menu, i.e. softkey layout within a screen. The different screens have a different number of menus, and some of the menu functions may be available on more than one menu.

Trip Reset

Softkey used to reset the trip distance log. See [“Screen pilot, Menu 1, trip/speed alarm.” on page 12.](#)

Sp(ee)d Alarm ▲ and ▼

Set a speed high alarm limit and a speed low alarm limit. See [“Screen pilot, Menu 1, trip/speed alarm.” on page 12.](#)

System On/Off

During normal daily operation, the system may be switched off from all primary screens. This operation does not disconnect the system from the power supply, but all power consuming components are switched off. The system may be switched on again by pressing any button. See [“Screen pilot, Menu 2, system.” on page 13.](#)

Note: In dock, the system must be powered off using the internal switch or circuit breaker. Power cycling the system when in “system off” mode, will restart the system.

Depth range

(When activated) adjusts the displayed range on screen. See [“Screen pilot, Menu 2, ES mode settings.” on page 81.](#)

Installation functions

Alarm buzzer

The local alarm buzzer may be disabled, but the external alarm relay will always operate. The only way to disable the alarms completely, is to reduce the low speed alarm to zero and increase the high speed alarm to maximum range. See [“Screen status, Menu 3, boat setup/buzzer.” on page 23.](#)

Alarm acknowledgement

When any alarm is activated, the alarm may be acknowledged by pressing any button. Alarm relay and audio alarm may be acknowledged by sending the “ACK” NMEA message from an alarm handling system, or by operating a remote button that shorts the INHIB2 and INHIBREF lines on the combo terminal board, (INHIB 2 = J100 pin 11, INHIBREF = J100 pin 9). See [“Alarm connections” on page 47.](#)

Clock and Calendar Settings

Manual clock and calendar adjustments are carried out in [“Screen status, Menu 2, date/time.” on page 23.](#) If a satellite receiver giving UTC messages is connected to the NMEA input, the clock and calendar will be automatically updated and manual adjustment is not available.

Speed limits functionality

Implementation of the high and low speed limit values. When the measured speed is maintained between this two limits (taking into account the hysteresis characteristics), the optocoupler will be in state A (closed). When the speed is moving outside the limits, the optocoupler will be in state B (open). Status screen, menu 6 is dedicated for this speed limit functionality. Three buttons can be used to adjust minimal and maximal settings and the hysteresis.

This function can be used to signal speed limits for stabilisers or rudder limits. (**Note:** See ["Speed Limit function" on page 41](#) for more details)

Speed limit ▲ and ▼

Set a speed high alarm limit and a speed low alarm limit. See ["Screen status, Menu 6, speed limits and hysteresis" on page 25](#). for more details. When enabled, this alarm will replace pulse 1 output. Set both high and low values to zero to turn off the function.

Hysteresis

Hysteresis, if the speed is on the limit of the speed setting, setting hysteresis will mean the speed must change above this limit before returning to cause a new alarm.

Power failure alarm

Power failure alarm is required in most installations. The alarm relay will click to "on" position when power is applied, and if power is lost, or a function alarm is activated, it will switch to the "off" position. If a separate power failure alarm is required, the J100 pin 12 - 13 output can be used. This is opto isolated, and will need an external voltage applied. See ["Alarm relay" on page 41](#) for more details.

Pulse output

Three pulse outputs are available, these are opto-coupled outputs that require a voltage input to operate. See ["Misc I/O connections" on page 46](#) for more details. The output is pulses per nautical mile, adjusted in the status screen. If the speed limit function is in use, pulse number 1 will be redesignated to that function.

Analogue output

The cabinet is equipped with analogue outputs to supply analogue repeaters or other equipment with analogue inputs. The signals are galvanically connected to the unit. See ["Analogue interfaces" on page 42](#) for more details. Standard range is 0 - 10 V or 4 - 20 mA corresponding to ANA MIN and ANA MAX settings. These settings may be accessed on ["Screen status, Menu 5, analogue settings." on page 24](#).

Diagnostic functions

Built in test (BIT)

Built in test (BIT) is a function that runs a series of tests to try to find known errors within the system. The system will test communication, some of the electronics, and the acoustical characteristics of the transducer/sensor. BIT will not find all problems, but if it recognises a problem, it will give the result in the frame marked 'Possible reasons'. More information about the tests is available on the manufacturers web pages.

Scope

The Diagnostics screen (with DETAILS "on") has a scope function (DIGITIZED) allowing the user to look at the individual returned waveforms on each of the sensors transducers, both in the water track ping and bottom track ping. This allows the user to diagnose faults on the individual beams.

3. User Maintenance

Transducer Maintenance

The transducers are virtually maintenance free, but occasional cleaning may be necessary depending on sea water conditions.

Operator Unit and Transceiver Unit Maintenance

The operator and transceiver unit contains no user serviceable parts, and requires no maintenance apart from occasional cleaning of the front panel. Please use a soft cloth and **no chemicals** except **cleaning alcohol**.

Note: Dry docking the vessel. The transducer will only tolerate short periods in air. When the vessel is placed in dock, or the transducer is lifted, the power must be shut off at the switch or circuit breaker. The softkey SYSTEM off only places the system in standby, and power glitches may activate the system.

4. Installation

This chapter contains information related to installation of the Doppler speed log. Please ensure you perform all the following subsections:

- Installation of bottom parts/transducer.
- Operator unit installation, see [“Operator Unit Installation” on page 36.](#)
- Turn on memory (backup battery jumper JP200), see [“Back-up Battery Jumper JP200” on page 38.](#)
- Interfacing, see [“Operator Unit - Connecting External Equipment” on page 44.](#)
- Selecting voltages, see [“Old PLD version in Transceiver Unit” on page 40](#) and [“115/230 V selection on backplane inside Transceiver Unit” on page 76.](#)
- Connecting the transceiver unit. See [“Transducer Installation” on page 36.](#)
- Checking, see [“5. Start-up and system adaption” on page 48.](#)

Handling warning

- **The Doppler system is a sensitive measuring device, all parts must be handled carefully. Please pay particular care with handling of the bottom parts and follow all instructions with regards to handling and installation.**
- **The transducer is supplied with a foam packaging. Keep this in place until the sensor is placed in the valve.**

Standard System Supply

A basic Doppler system consists of the following units, (see [overview drawings in chapter “10. Appendix 1” on page 68.](#))

- Display/operator unit.
- Communication cable (if ordered, else yard supply).
- Transceiver unit.
- Sensor cable.
- Transducer (sensor).
- Bottom parts, usually a sea valve assembly.

For bottom part installation and placement, see separate manuals.

Additional manuals are available from your supplier (contact information on cover page).

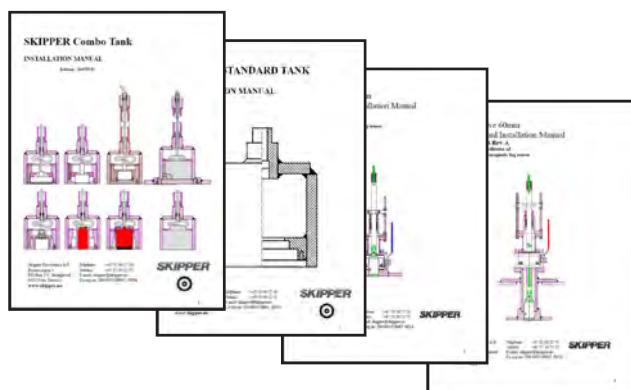

Transducer Installation

Location

- It is recommended to install the transducer in foreship.
- Optimal system operation is achieved by fitting the transducer as deep as possible on the hull.
- The transmitting surface of the transducer must be installed horizontal.
- Do not mount transducers close to the bow thruster propeller outlets, or aft of other hull installations (outlets, vents or other protruding details).
- It is necessary to select a part of the hull that is submerged under all load and speed conditions, and to avoid positions where air is trapped in heavy weather.
- If a flat, horizontal section is not available for transducer fitting, the shipyard must construct a suitable bed.

Protect the active element of the transducer and **do not paint the surface.**

Note: See [chapter “10. Appendix 1” on page 68](#) for more information about connecting transducer to transceiver cabinet.

Important note: During installation, **DO NOT CUT THE TRANSDUCER CABLE.** The transducer, transducer cable and transceiver cabinet are all “balanced parts”. Therefore cutting the cable may deteriorate performance and will also void the warranty.

Operator Unit Installation

Select a position to provide free view of the panel as well as easy access during operation and service. The operator unit may be mounted flush in a panel, on a wall or directly onto a bulkhead. For more information, see “[Dimensional Drawing Cabinet](#)” on page 75, that shows the operator unit along with the main installation drawings. If the unit is to be flush mounted, the shown cut-out and recession depth dimensions must be observed. Remember to leave room in front of the unit to open the door a full 90°.

Do not perform installation work with system power applied!

Cables are led through the appropriate cable glands as follows:

- The cable from the transceiver unit should normally occupy the left gland.
- The right gland is used for power supply connection.
- The centre ones are used for any interface signals connected.

115/230 V selection on Combo Terminal board inside Display Unit

Power supply may be either 115/230 V AC or 24 V DC. Power consumption is app. 50 W at 24 V DC and app. 70 W at 115/230 V AC. If the AC power system is 115 V, the system must be prepared for 115 V by re-connecting the connectors J102, J103. Fuses are shown in fig. 4.1 for 115/230 V AC and 24 V DC. These fuses are normal 5 x 20 mm slow blow glass fuses.

- 115 V AC: FS100, FS101: 1.0 A.
- 230 V AC: FS100, FS101: 0.5 A.
- 24 V DC: FS102: 3.15 A.

When the installation is complete, and power is connected to the operator unit, the appropriate power switch next to the power terminals is switched on. For daily operation, these switches may stay on and the unit is switched off by pressing the “SYSTEM off” button. The unit is switched on by pressing any button.

Both 115/230 V AC and 24 V DC power may be connected and switched on at the same time. If one of these supplies shuts down, change over is automatic.

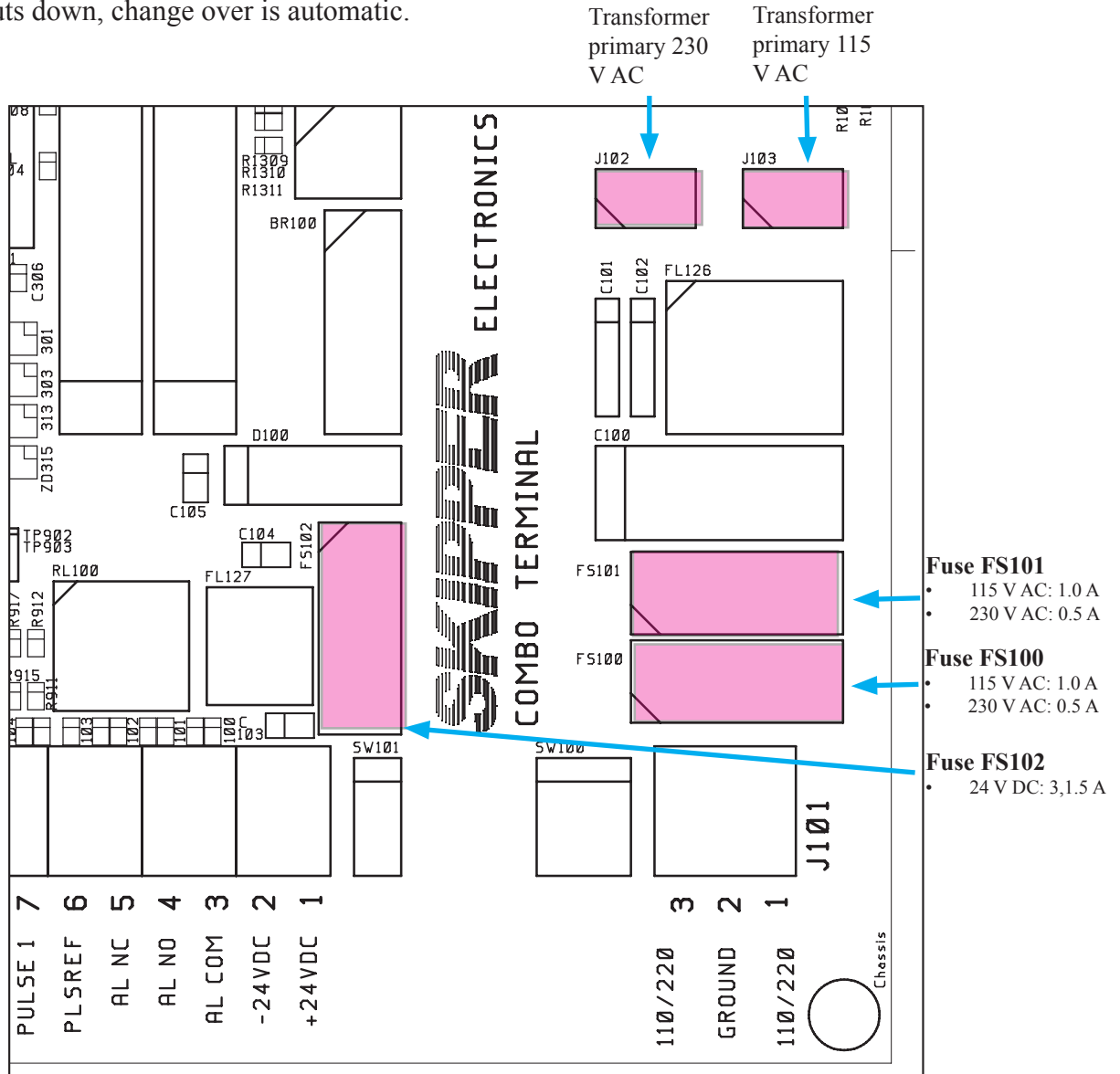

Fig. 4.1 Voltage selection connectors and fuses, Terminal Board.

AC Voltage selection

- Transformer primary to: J102 for 230 V AC and J103 for 115 V AC.
- Fit dummy plug on opposite connector for protection.

Fuses

- 230 V AC: FS100 and FS101 must be 0.5 A slow blow.
- 115 V AC: FS100 and FS101 must be 1.0 A slow blow.
- 24 V DC: FS102 must be 3.15 A slow blow.

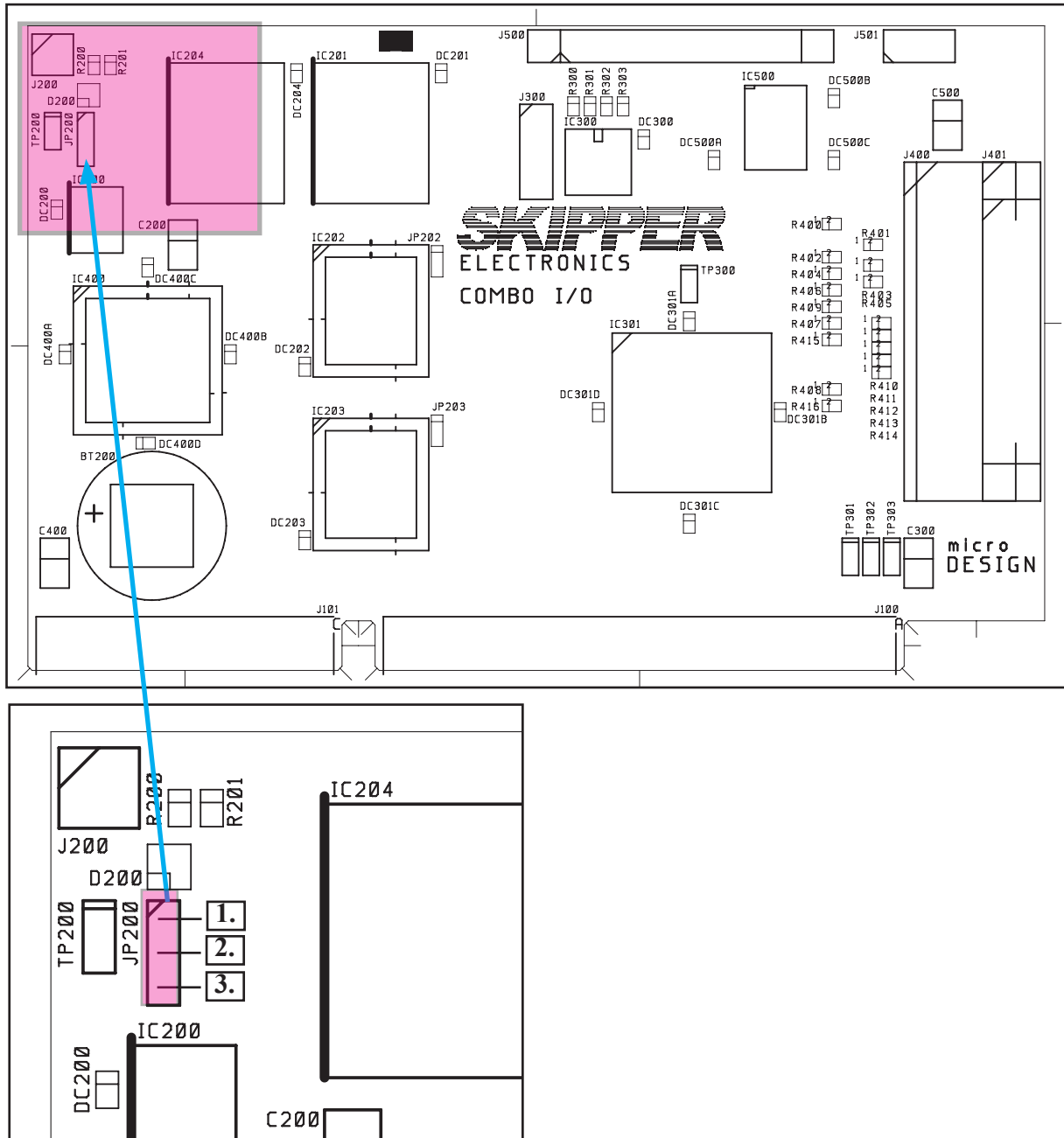

Fig. 4.2 Static Memory Battery Jumper, I/O Board.

Back-up Battery Jumper JP200

Note: After installation is complete and system power is applied, it is necessary to connect the static memory battery to provide power to the user parameters during system power failure.

Refer to Fig. 4.2 for the correct setting of the battery jumper “ON” position 2-3. This jumper should be set to the “OFF” position 1-2 only during extended unit storage periods. The battery is used only when no power is applied to the power terminal.

Note: If the system beeps 4 times on startup, the jumper is in “OFF” position or the battery voltage is low (< 3 V).

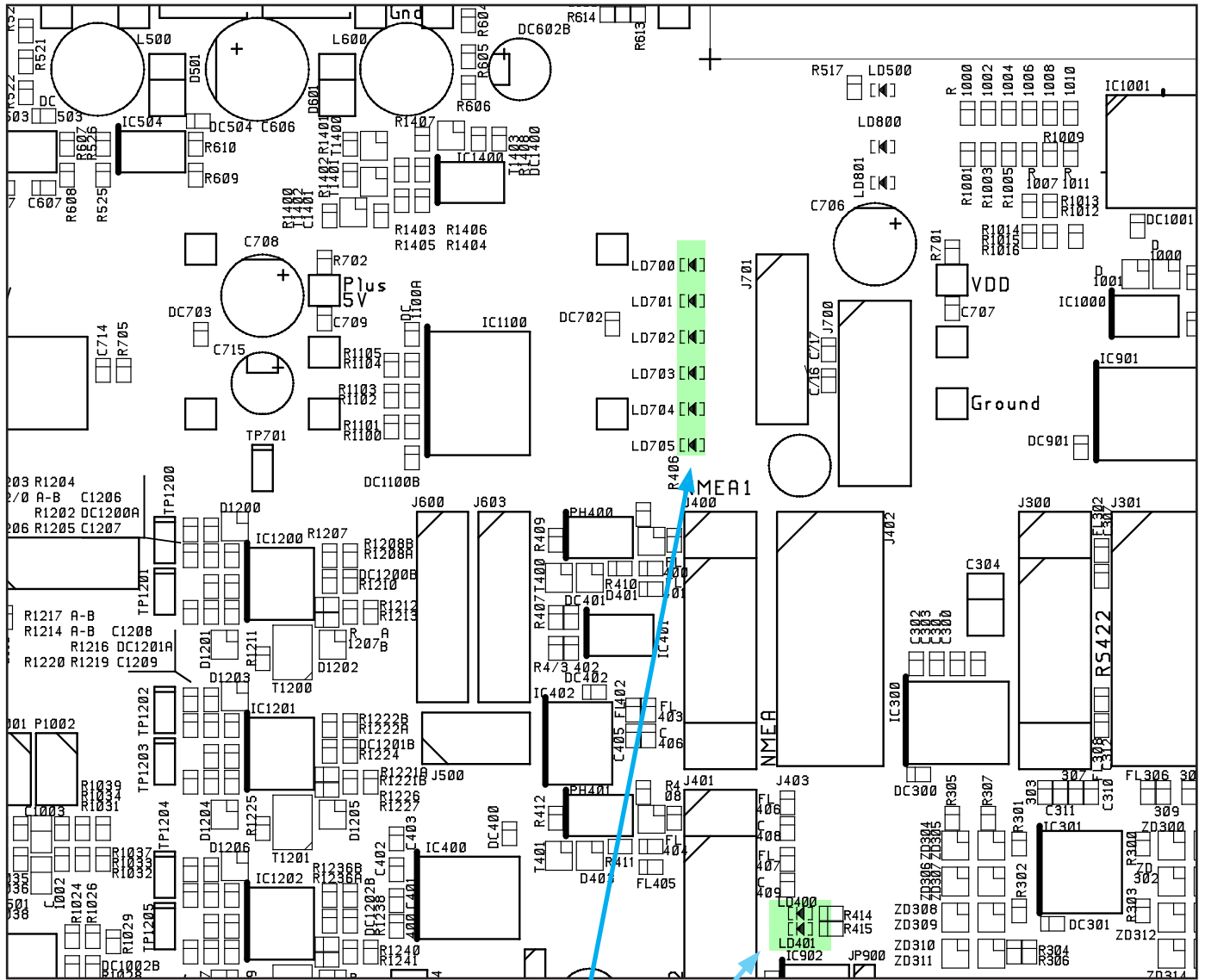

Fig. 4.3 Function LEDs, on terminal board

Power indication and function LEDs

The following LEDs are located on the terminal board:

- LD400 NMEA signal activity on receive input 1.
- LD401 NMEA signal activity on receive input 2.
- LD700 +5 V#1/VCC (board external and CPU).
- LD701 +12 V#1/VDD (board external).
- LD702 +5 V#2 (board internal).
- LD703 +12 V#2 (board internal).
- LD704 -12 V.
- LD705 -5 V.

Fig. 4.3 indicates position of these LEDs.

Old PLD version in Transceiver Unit

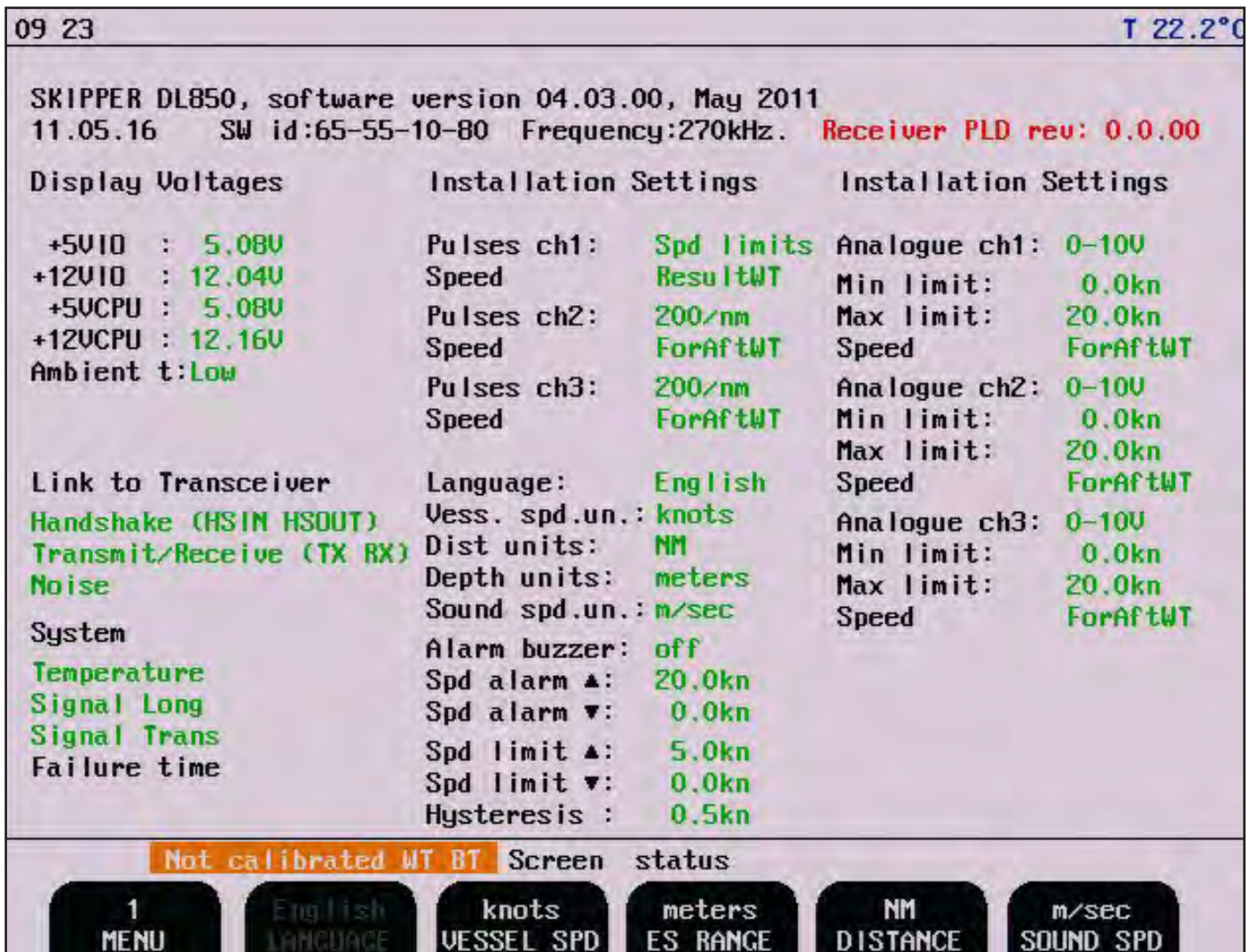

Important note: If, after power-up, on screen status, you see the following message “Receiver PLD rev: 0.0.00” in the upper right corner, this is an indication of old PLD in the transceiver unit. The unit will work, but is not optimized. Replace PLD with correct version, (1.0.00) or contact your local supplier for more information.

Part number: LG-T001

Note: Screen picture is showing Sw 4.03.00. Text also valid for Sw 4.03.03.

Interfacing

Alarm relay

An alarm relay is provided for interconnection to external alarm systems. This relay is normally energized, and is released by alarm conditions or power failure/power off. The terminals have the following significance:

Pin nr	Name	Description
J100 - 3	AL COM	Common terminal.
J100 - 4	AL NO	Normally open contact.
J100 - 5	AL NC	Normally closed contact (normal = "No alarm" condition).
J100 - 12	OPTDC	Separate power failure alarm +.
J100 - 13	OPTDE	Separate power failure alarm -.

Combined operational alarm and power failure alarm. See "[Alarm connections](#)" on page 47.

Log Pulse Outputs

Pulse output terminals are as follows:

- Each group of pulse outputs are galvanically separated.
- All pulse outputs are opto couplers.
- The pulse rates and output modes are programmable in "[Screen status, Menu 4, pulse settings.](#)" on page 24.
- Possible pulse rates are 10/100/200/400/1000 pulses per nautical mile. (1000 pulses Ch 3 only).
- Possible output modes are ForAftWT, LateralWT, ResultWT, ForAftBT, LateralBT, ResultBT.

Pin nr	Name	Description
J100 - 21	OPT3DC	Optocoupler 3, direction collector.
J100 - 20	OPT3VC	Optocoupler 3, velocity collector.
J100 - 19	OPT3EE	Optocoupler 3, common emitters.
J100 - 18	OPT2DC	Optocoupler 2, direction collector.
J100 - 17	OPT2VC	Optocoupler 2, velocity collector.
J100 - 16	OPT2EE	Optocoupler 2, common emitters.
J100 - 15	OPTVE	Optocoupler 1, velocity emitter. Pulses ch 1, or speed limit function when activated.
J100 - 14	OPTVC	Optocoupler 1, velocity collector. Pulses ch 1, or speed limit function when activated.

Pulse output is default set to water track in Fore/Aft direction (ForAftWT). For special purposes as ship maintenance or measuring of travelled distance in rivers, the pulse output may be set to give other types of speed such as ResultWT, ForAftBT or ResultBT. This option is protected and can be activated by using the hidden button as described in the chapter for calibration. See "[Activation of the hidden menus](#)" on page 52.

Note: If the high speed limit (Sp(ee)d limit ▲) and low speed limit (Sp(ee)d limit ▼) are both equal = 0 kts, the optocoupler output ch 1 (OPTVC and OPTVE) is operating as the standard speed pulse output. If the speed limit values are <> (different from) 0 kts, the optocoupler output ch 1 is designated as speed limit function. (See illustration on screen status on previous page).

Speed Limit function

When the speed limit function is activated, (not 0 in both Sp(ee)d limit ▲ and Sp(ee)d limit ▼ (see

status screen)) pins 14 and 15 will be designated this warning. This warning is typically used to limit the systems steering at higher speeds, or to block incorrect usage of equipment that should not be used at high speeds (stabilisers or winches). Upper (▲) and lower (▼) limits can be set on screen status menu 6 to provide a window of operation for this function. When activated, Pulse 1 will not be available.

Note: Optocoupler output OPTVE and OPTVC are (if activated) dedicated to the speed limit function. Switch is closed, if the speed is inside the limits, and open if the speed is outside the limits. If closed contact is required, it must be connected as shown in diagram 4.6, see [“Misc I/O connections” on page 46](#).

Inputs

Pin nr	Name	Description
J100 - 6	PLSREF	Reference for pulse inputs.
J100 - 7	PULSE 1	Not used.
J100 - 8	PULSE 2	Not used.
J100 - 9	INHIBREF	Reference for inhib inputs.
J100 - 10	INHIB1	Not used.
J100 - 11	INHIB2	Remote silence of alarm buzzer.

Note: Short between INHIB2 (J100 pin 11) and INHIBREF (J100 pin 9) used for remote silence of alarm buzzer.

Analogue interfaces

The display unit is equipped with 3 analogue outputs to supply analogue repeaters or other equipment with analogue signals. The signals are galvanically connected to the cabinet ground. Standard range is 0 - 10 V or 4 - 20 mA. The velocity vectors and output modes are programmable from status screen, menu 5.

Pin nr	Name	Description
J100 - 22	ANAREF	System ground, common negative reference for analogue outputs.
J100 - 23	ANAOUT1	Analogue output 1.
J100 - 24	ANAOUT2	Analogue output 2.
J100 - 25	ANAOUT3	Analogue output 3.

NMEA interface

The NMEA output provides IEC 61162-1:2007(E) (NMEA 0183) format information for other equipment with NMEA 0183 inputs. Default setting is 4800 Baud, 8 data bit, 1 stop bit, no parity. Several messages may be selected on screen COM and the enabled messages are transmitted with maximum interval of 1.8 seconds. The NMEA inputs accept alarm, position, rate of turn, heading and UTC time messages from various navigators and compasses. One output can drive minimum of 10 standard NMEA 0183 inputs.

See chapter [“5. Start-up and system adaption” on page 48](#), for a complete list of transmitted and received messages.

Options

Repeaters/Slaves

Graphic CRT (VGA) or LCD displays or digital slave repeaters may be connected to the system. Most repeaters with speed can be used via the NMEA 0183 output. However, the manufacturer recommends: IR300 and CD401

External Interface Ports



- 5 x PG 13.5 cable entry 10-12 mm
- Ground Stud
- XJ402: NMEA ports D-SUB 9 pin female
- XCN6: VGA terminal HDD-SUB 15 pin female
- XCN3: Not used D-SUB 25 pin female

If required, the PG glands can be moved to other blinded holes. Extra holes are also available on back side of cabinet.

Operator Unit - Connecting External Equipment

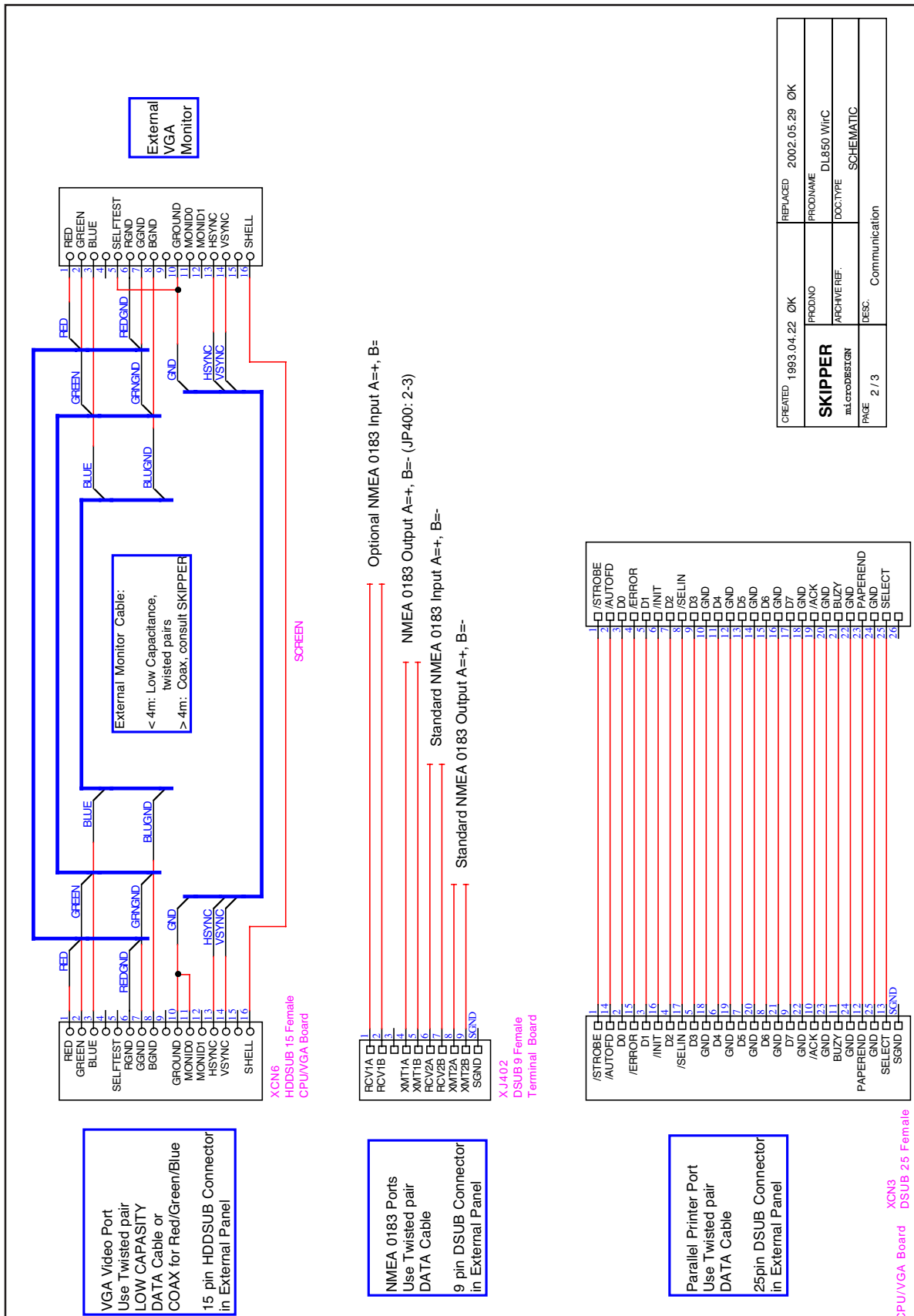

Fig. 4.4 Connecting external equipment

Operator unit - Terminal connections

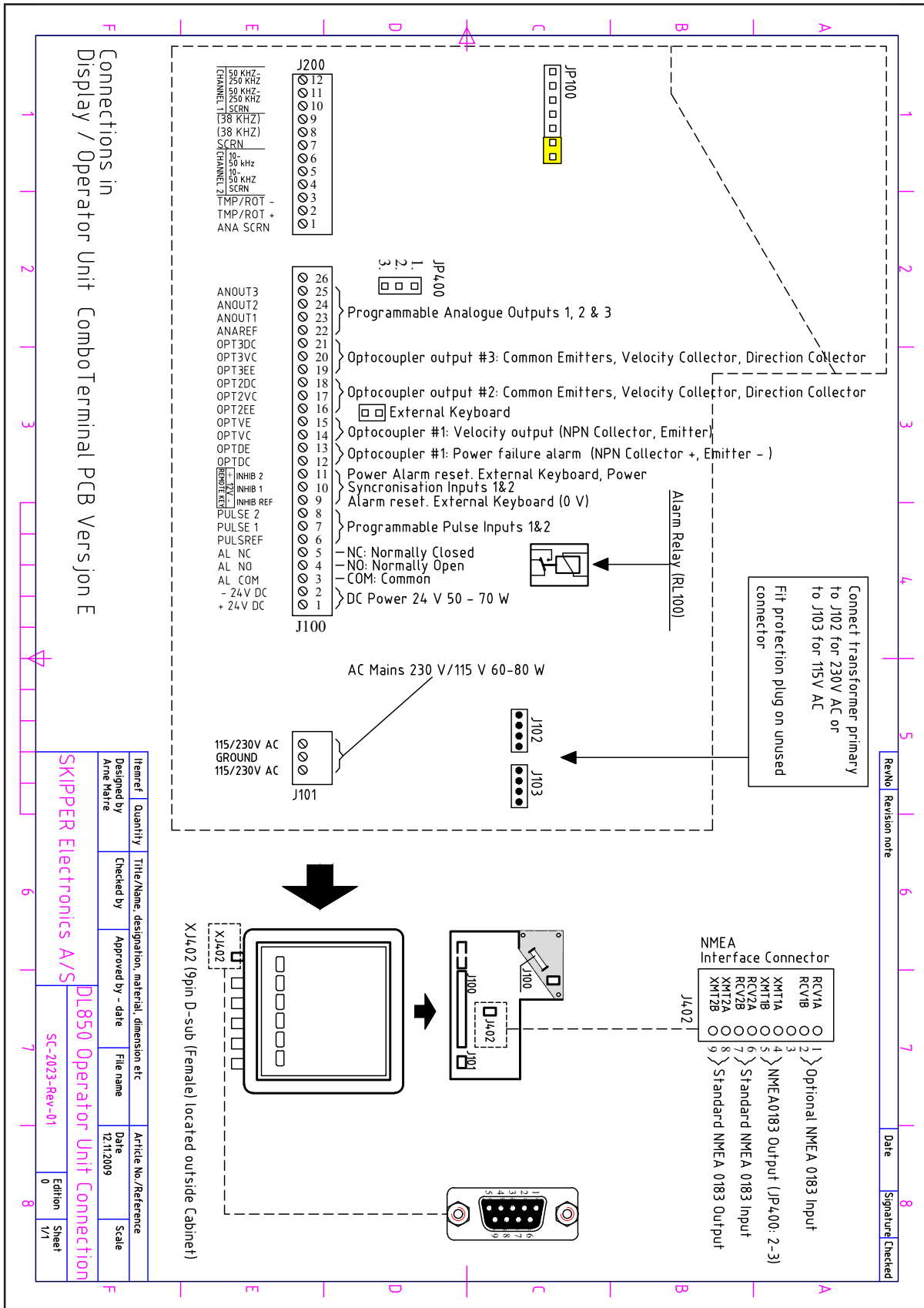

Fig. 4.5 Terminal connections

Misc I/O connections

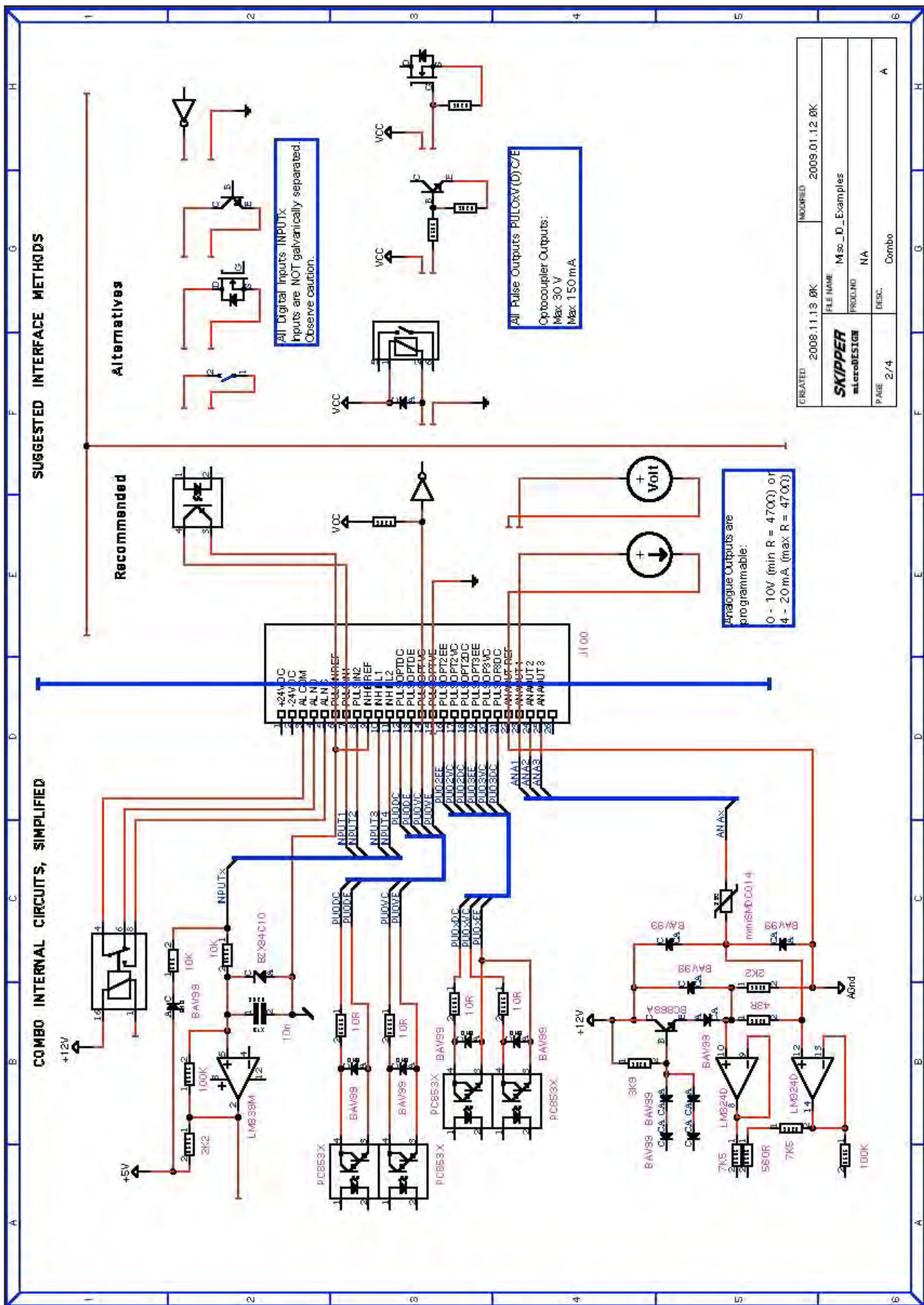

Fig. 4.6 Misc I/O connections

Alarm connections

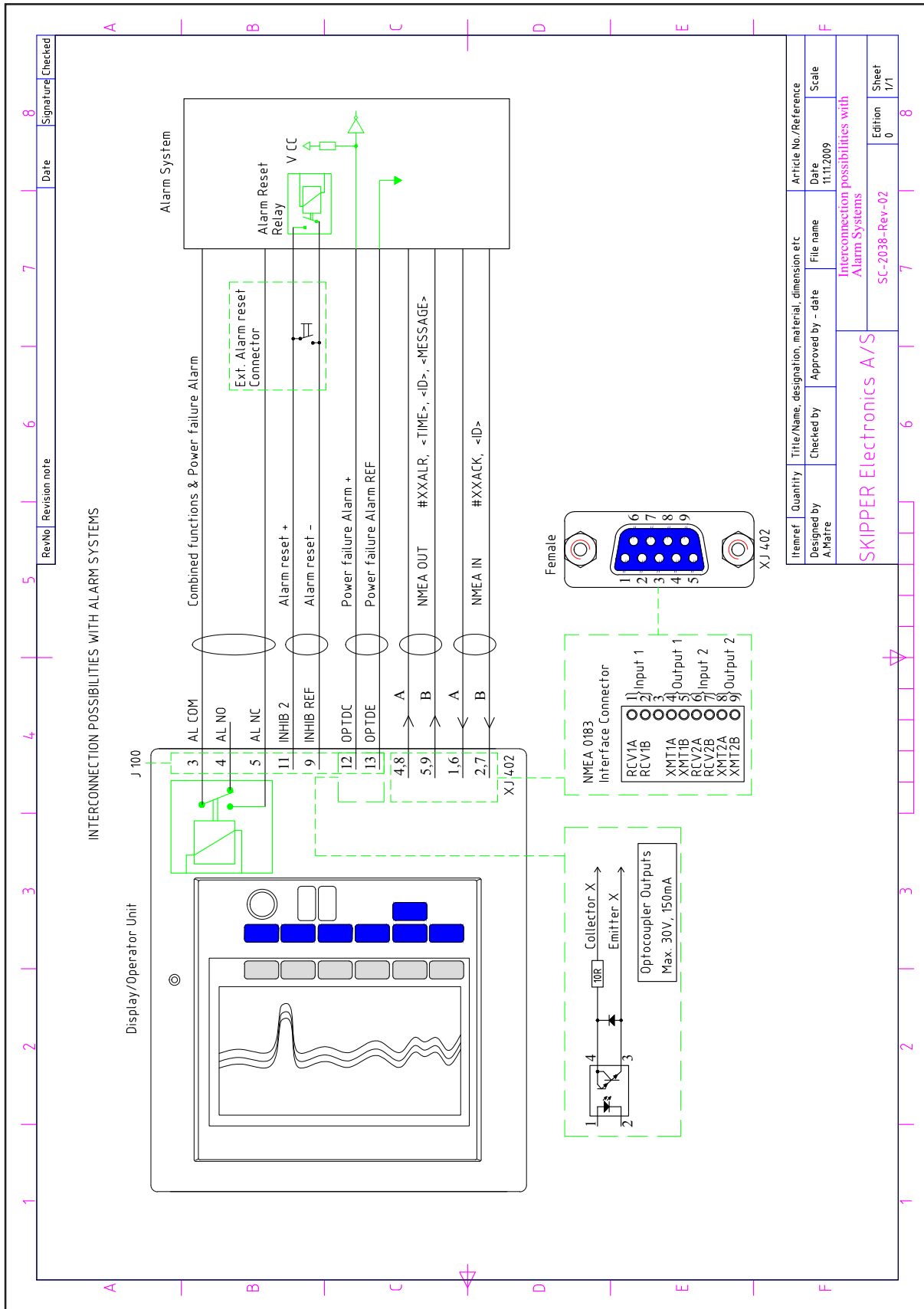

Fig. 4.7 Alarm connections

5. Start-up and system adaption

System Adaption

Analogue outputs and log pulse outputs range selection

From [“Screen status, Menu 4, pulse settings.” on page 24](#), it is possible to set number of pulses per nautical mile (10/100/200/400/1000) for the log pulse outputs. **Note:** 1000 pulser per natical mile only on OUT NUM 3.

Units of Measure

From [“Screen status, Menu 1, units.” on page 22](#), it is possible to select unit of measure for the screen.

Units of measure may be selected for:

- Vessel speed: knots, km/h, miles/h, m/sec.
- Depth (ES Range): meters, feet, fathoms, braccias.
- Distance: NM, km, mi.
- Sound speed: m/sec, ft/sec, knots, km/h, mi/h.

NMEA Setup

Screen COM is used for verification of received and control of transmitted IEC-61162-1:2007(E) (NMEA 0183) messages. The 4800 baud rate is the most common, but the baud rate may also be set to other values to interface with different kind of equipment. When a NMEA talker is connected to one of the inputs, all received messages will be displayed on the screen. If no messages are displayed, check the signal polarity, the baud rate and input mode (input, output or off). If messages are marked red, check message protocol.

There are two NMEA inputs, COM 1 and COM 2. In case of two inputs with different baud rates, example gyro with 115200 and GPS with 4800, you may connect the GPS to COM 1 (XJ402 pin 1 - 2) and the gyro to COM 2 (XJ402 pin 6 - 7). For details, see [“Operator Unit - Connecting External Equipment” on page 44](#) and [“Operator unit - Terminal connections” on page 45](#). Baud setup is found on [“Screen com, Menu 2, NMEA com setup.” on page 20](#).

The following messages are accepted for input and interpreted by the program. The talker identifier is ignored.

Time

Day, month, year	ZDA,hhmmss.ss,xx,xx,xxxx,xx,xx*hh<CR><LF>
------------------	-------------------------------------------

Position

Geographical lat/lon	GLL,llll.ll,a,yyyy.yy,a,hhmmss.ss,A,a*hh<CR><LF>
GPS position	GGA,hhmmss.ss,llll.ll,yyyy.yy,a,x,xx,x.x,x.x,M,x.x,xxxx*hh <CR><LF>

Rate of Turn

Rate of turn	ROT,x.x,A*hh<CR><LF> (Required for docking.)
--------------	----------------------------------------------

Alarm

Acknowledge alarm	ACK,xxx*hh<CR><LF>
-------------------	--------------------

Heading

Heading, true, present	HDT,xx.x,T*hh<CR><LF>
True heading and status	THS,x.x,a*hh<CR><LF>

Composite

Loran C specific	RMA,a,xxxx.xx,N,xxxxx.xx,W,,xx.x,xxx,,*xx<CR><LF>
GPS, transit specific	RMC,hhmmss.ss,A,llll.ll,a,yyyy.yy,a,x.x,x,xxxxxx,,*hh <CR><LF>

Doppler log transmitted (talker) (IEC 61162-1:2007(E) (NMEA 0183) messages:**Speed and distance**

Name	Description	Example
VTG	Course over ground and ground speed	\$VDVTG,,,,,x.x,N,x.x,K,a*hh<CR><LF>
VHW	Water speed and heading	\$VDVHW,,,,,x.x,N,x.x,K*hh <CR><LF>
VLW	Dual ground/water distance	\$VDVLW,x.x,N,x.x,N*hh<CR><LF>
VLW IEC07	Dual ground/water distance	\$VDVLW,x.x,N,x.x,N,x.x,N,x.x,N*hh<CR><LF>
VBW	Dual ground/water speed	\$VDVBW,x.x,x.x,A,x.x,x.x,A,x.x,A,x.x,A*hh <CR><LF>

Temperature

Name	Description	Example
MTW	Water temperature	\$VDMTW,x.x,C*hh<CR><LF>

Alarm

Name	Description	Example
ALR	Set alarm state	\$VDALR,hhmmss.ss,xxx,A,A,<Alarm message> *hh<CR><LF>

Depth

Name	Description	Example
DPT	Depth	\$IIDPT,x.x,x.x*hh<CR><LF>
DBT	Depth below transducer	\$IIDBT,x.x,f,x.x,M,x.x,F*hh<CR><LF>
DBK	Depth below keel	\$IIDBK,x.x,f,x.x,M,x.x,F*hh<CR><LF>

Values will be preceded with sign as needed (e.g “-“ = Astern, Port).

*hh = Checksum.

Quality

Name	Description	Example
STA	Quality	\$PSKPVDSTA,<wsl>,<wst>,<bsl>,<bst>,<wal>,<bal><checksum><CR LF

A new proprietary NMEA message, indicating the quality of the information from the sensor has been implemented. (**Note:** Continued on next page).

The format is the following:

\$SPSKPVDSTA,<wsl>,<wst>,<bsl>,<bst>,<wal>,<bal><check sum><CR LF> where

<wsl> - WT (speed through water), signal quality in %, longitudinal axis.

<wst> - WT (speed through water), signal quality in %, transversal axis.

<bsl> - BT (speed over ground), signal quality in %, longitudinal axis.

<bst> - BT (speed over ground), signal quality in %, transversal axis.

<wal> - WT (speed through water), validation of acceleration in m/(sec)².

<bal> - BT (speed over ground), validation of acceleration in m/(sec)².

The first 4 fields are presenting 3 levels of data quality % which are based on the percentage of the good measurements samples within the total population, which is defined by the parameter Number of Averages. The values are individual for each operation mode (WT/BT) and for each axis.

Values are in %, where:

- more than 50 % is generally good.
- 25 % - 50 % is generally warning.
- less than 25 % is generally bad.

The last 2 fields are presenting 3 levels of data quality, which is based on the maximal acceleration within 3 latest successful samples.

These parameters can be used for a bridge system to predict potential problems and switch to a secondary system.

Docking option parameter setup

Two parameters must be set to ensure that the docking option is showing the correct stern speed. See [“Screen status, Menu 3, boat setup/buzzer.” on page 23.](#)

- **Sensor to bow:** Total length from sensor location to the bow.
- **Ship length:** Total ship length, bow to stern.

6. Calibration procedure

Speed logs are calibrated in the factory to give reasonable results after installation, however installation and hydrodynamics vary from vessel to vessel. It is therefore necessary to calibrate speed logs once in place.

SKIPPER speed logs have two parameters that need to be corrected by calibration.

1. Angular sensor installation error (heading error).
2. Speed variations due to drag or mounting tilt.

1. Heading Error



The heading error parameter corrects for an angular offset in mounting. This offset will result in a rotation of the measurement axes. The resultant speed will be unaffected, but the longitudinal and transversal components will be incorrect. An offset will result in the vessel typically showing too much transversal speed, but may also result in speed calibration failing (i.e. initial calibration fails when further points are added). This offset will show itself as an averaged drift on the calibration.

Reducing Heading errors. New generation sea valves can be manually adjusted to ensure the sensor is correctly aligned. Alignment and heading offset are directly connected. To minimize the offset, the sensor should be mounted pointing ahead.

- **Tank mountings** have ahead marks on both the tank and the sensor insert.
- **Sea valves** have either a mark on the top flange (DL850 540 retro fit system) or a flat mark on the port side of the pole which when a flat object is placed against this, will point fore/aft (Figure 6.1).

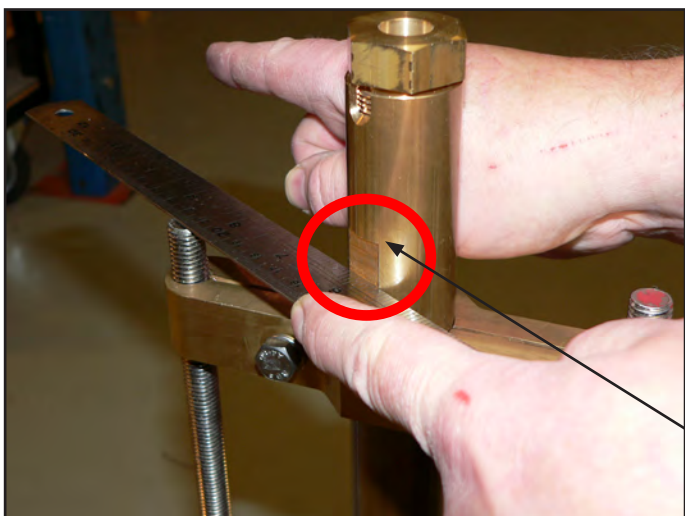

A flat object points fore/aft.

Fig. 6.1 Sea valve alignment

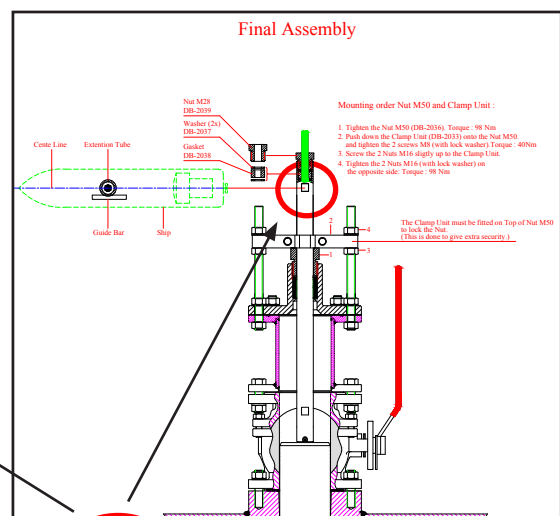

The flat side should be on the port side.

2. Speed variations due to drag or mounting tilt.

Every vessel will drag some water when it moves. This occurs over the whole hull. As you move further from the hull, the effect of the ships movement gets less. As the vessel moves at different speeds, the hydrodynamics of the vessel may change. In most cases the drag is even over the whole range of the vessel.

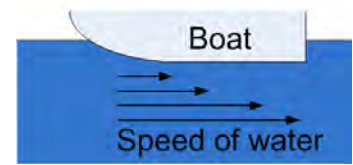

Speed logs that measure on the surface of the vessel (such as EML) are more affected by this factor than sensors that measure remotely (Doppler). The calibration variation is usually less on remote sensors.

As the calibration factors can vary at different vessel speeds, it is possible to calibrate several speeds. It is typically necessary with only one high and one low speed. Speed logs with speed over ground can be compared with GPS speed over ground in stable conditions. However speed through water measures the influence of currents on the vessel, which cannot normally be measured on any other system. It is therefore important that full calibration is performed at least once for speed through water.

Calibration routine:

As previously explained, there are two factors to be calibrated, heading error and speed. Speed over ground can be calibrated in two ways. Speed through water can be approximated, but should be calibrated by sailing on opposite courses to get an accurate value.

All calibration functions are located on the **Calibration** screen. In order to select this screen, press “SCREEN SELECT” button in the lower row of the panel buttons and while keeping it pressed, turn encoder until desired screen appears on the display.

Activation of the hidden menus

To avoid accidental access to the internal settings, all calibration functions are disabled during normal operation. In order to activate them, do the following:

- Open front door of the cabinet and find a “hidden” key on the component side of the keyboard PCB (upper/left corner of the PCB).
- Press key mentioned above and keep it pressed for 2-3 seconds, until “Calibration enabled” message is observed in the right/upper corner of the screen. The text on the soft keys will change colour from grey to white, which indicates availability of the corresponding functions.

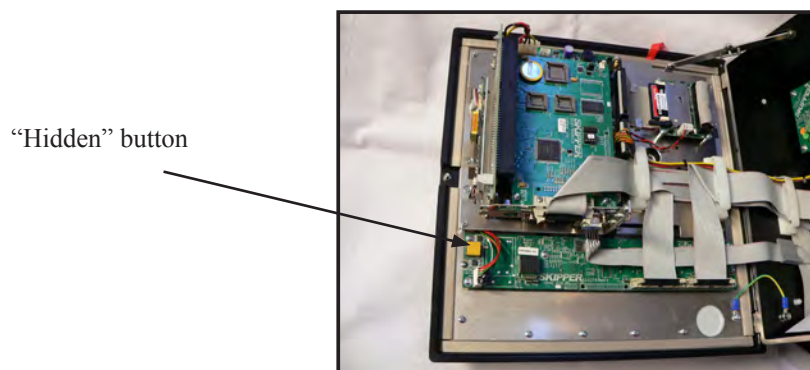

Note: After calibration is finished, disable access to the calibration functions simply by pressing the key again. Calibration mode is also disabled after a power recycling.

Step 1. Heading error correction:

The vessel sails a steady course in calm waters and the user reads the resultant angle (averaged drift). This is entered into the system using the **Head err** button and encoder on menu 3, and adjusted until the **averaged drift** angle is zero.

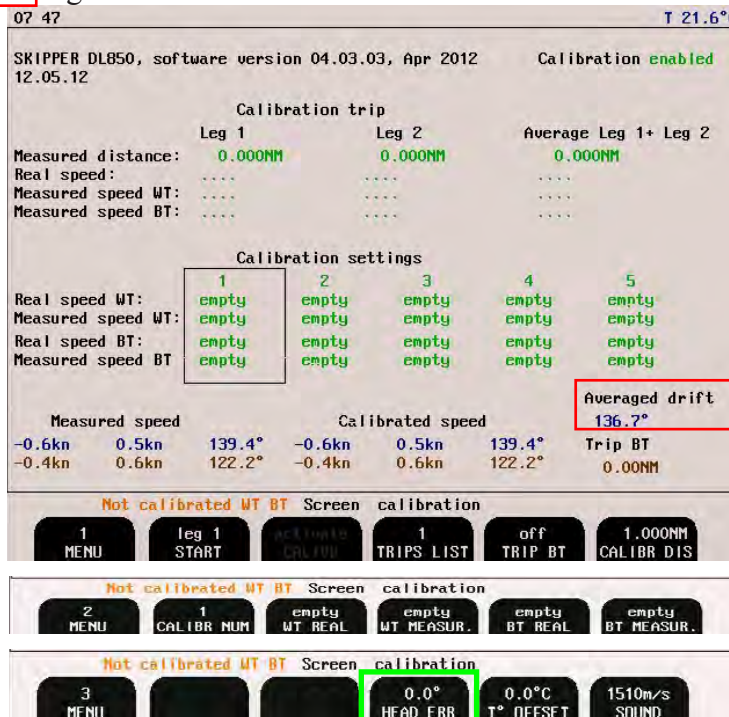

Step 2a. Manual speed calibration/adjustment:

The user enters speed values directly into the calibration table by comparing to other equipment, such as GPS. This can also be used to adjust values. Menu 2 allows you to enter the values directly. Press and hold an empty button will take the current values and place them in the table.

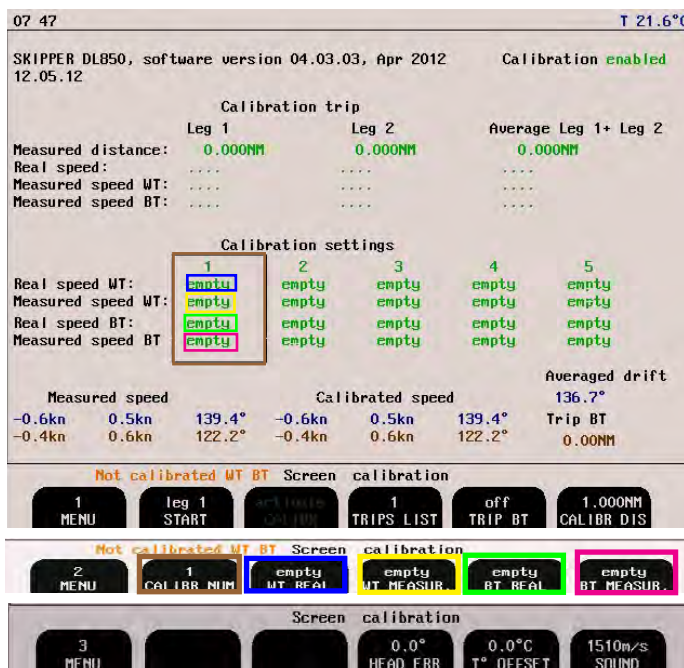

Screen calibration showing manual adjustment.

Placing values in the BT (Bottom Track) fields are valid. Doing this in the WT (Water Track) is not accurate. (Step 2b is recommended).

Step 2b. Semi Automatic calibration:

The vessel is made to sail a known distance and course in both directions. This to remove any water current factors from the speeds.

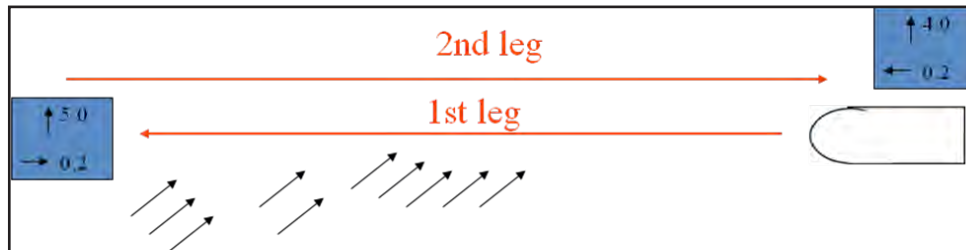

The 1st leg will show a different speed to the 2nd leg, however the direction changes in the second leg so that the average is correct.

The speed can be calibrated as follows:

1. Assuming you have performed step 1 “Heading Error”, plot a known distance on the chart. Enter this value into the **1.000NM CALIBR DIS** on menu 1.

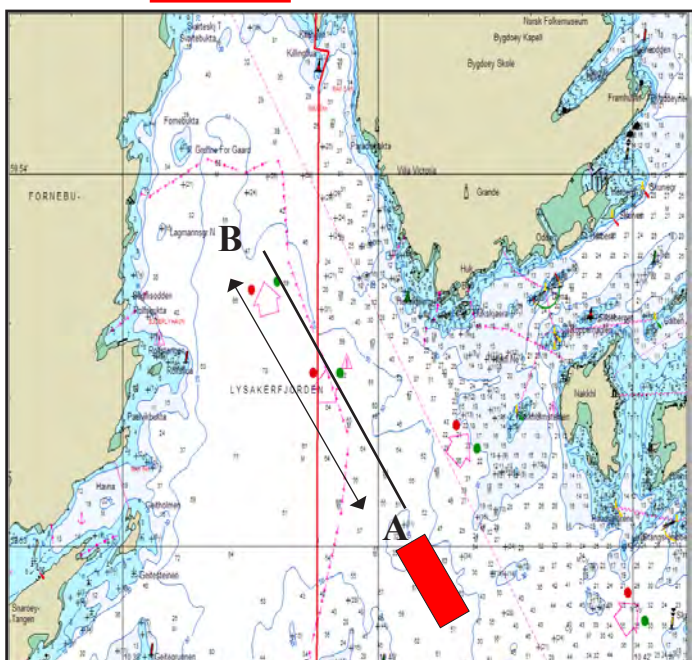
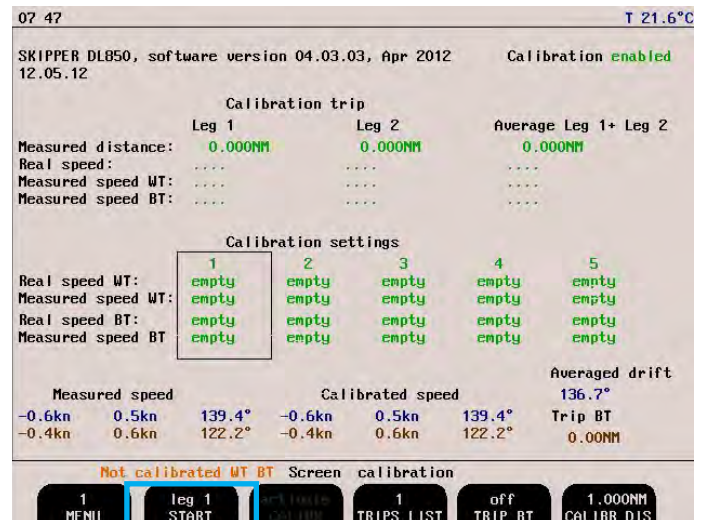
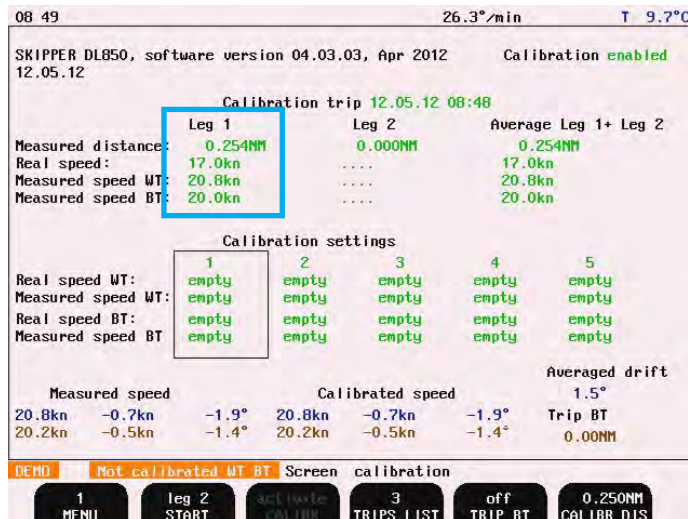

Figure shows plotting a calibration path on the chart.

The leg should take at least 5 minutes to sail (distance can be shorter when sailing slowly). Depth should be < 50 m to ensure that bottom track also calibrates correctly.

- Sail at a straight course in direction A to B and at a constant speed. When passing to point A, Press **START leg 1** on menu 1. The button text will change to FINISH leg 1 and a calibrating warning will show on the screen.



- Turn the vessel and repeat for leg 2 in the opposite direction at the same speed. The results will show in the Leg 2 table. The average of the two legs will show in the final table. This is the correct calibration.
- If the calibration looks correct, you may select which calibration settings table to place it in, and transfer using the **activate calibr** button (which will be active if the calibration is within limits).

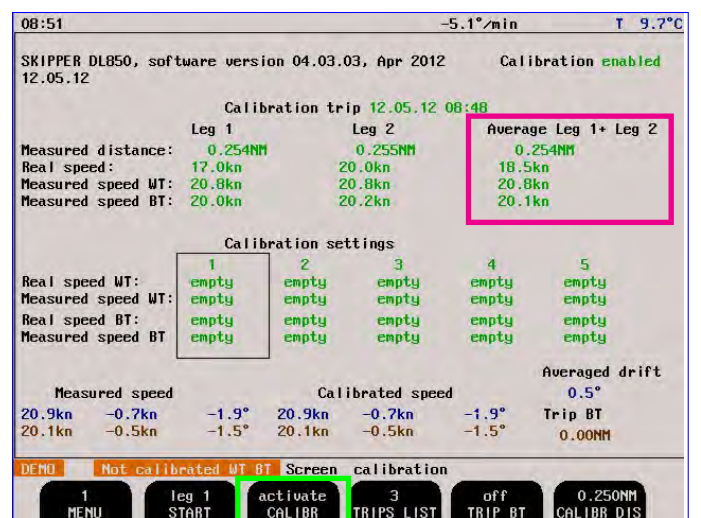
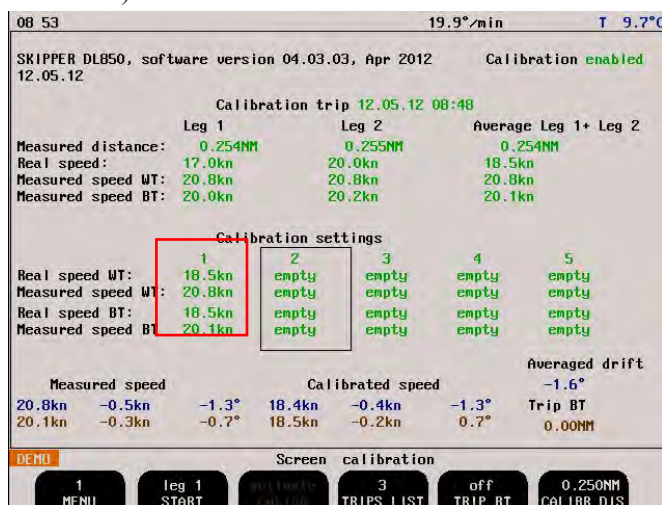

- You have now made a **calibration point**. We recommend a point at low speed (1-3 kn) and one at max speed (20 kn).
- Once calibrated, check the system at other speeds. If it is inaccurate, you may add more points (max 5).

Note: These values may be overwritten in some software upgrades or if master reset is performed. We advise recording the values somewhere, just in case. Doppler systems typically have a calibration factor within 10 % i.e. measured 9 kn, real 10 kn.

7. Trouble Shooting

Symptom	Cause	Remedy
Basic System Integrity		
No picture on LCD screen.	<ol style="list-style-type: none"> 1. No AC or DC power to the system. 2. System is in standby mode. 3. Too low screen contrast. 4. Defective LCD module. 5. Voltage(s) out of range. 	<ol style="list-style-type: none"> 1. Check switches and fuses on the terminal board inside the DL850 cabinet. 2. Press any button on the panel. 3. Increase contrast settings or replace keyboard PCB. 4. Replace LCD module. 5. Replace terminal board.
Display backlight malfunctions. Display picture is hardly visible.	<ol style="list-style-type: none"> 1. DL850 initialization. 2. Defective backlight tubes. 3. Defective backlight inverter PCB. 	<ol style="list-style-type: none"> 1. Turn off power and wait for 5 sec before restart. 2. Replace backlight tubes. 3. Replace backlight inverter PCB.
Rotary encoder malfunctions.	<ol style="list-style-type: none"> 1. Defective encoder or interface. 2. SW problem. 	<ol style="list-style-type: none"> 1. Replace keyboard PCB. 2. Recycle power/do a “factory reset”. <p>See “Master reset procedure.” on page 64.</p>
Panel buttons malfunctions.	<ol style="list-style-type: none"> 1. Defective buttons or interface. 2. One button stuck. 3. SW problem. 	<ol style="list-style-type: none"> 1. Replace keyboard PCB or I/O PCB. 2. Check key switch(es) or replace keyboard PCB. 3. Recycle power/do a “factory reset”.
Loose user setup and calibration data.	<ol style="list-style-type: none"> 1. Battery backup not enabled. 2. Battery flat. 	<ol style="list-style-type: none"> 1. See “Back-up Battery Jumper JP200” on page 38 for details. 2. Replace battery or I/O board.
Ambient t in status screen shows too high.	<ol style="list-style-type: none"> 1. Obstructed air flow. 2. Defective fan. 	<ol style="list-style-type: none"> 1. Check installations for obstructions of vent holes. 2. Replace fan.

Symptom	Cause	Remedy
Installation problems		
Status screen shows Handshake (HSIN HSOUT). The LEDs on the power and transmitter PCBs inside transceiver cabinet never turns on.	<ol style="list-style-type: none"> 1. Transceiver unit power is off. 2. A pair HSOUTA/HSOUTB on the display side or HSINA/HSINB on the transceiver side is not connected properly to the terminals or wrong polarity of the connection. 3. Damaged communication cable. 	<ol style="list-style-type: none"> 1. Switch on the power in the transceiver unit or check fuses. 2. Check connection and polarity of the handshake lines. 3. Test/replace cable.
Status screen shows Handshake (HSIN HSOUT) The LEDs on the power and transmitter PCBs are periodically turning on and off.	<ol style="list-style-type: none"> 1. A pair HSINA/HSINB on the display side or HSOUTA/HSOUTB on the transceiver side is not connected properly to the terminals or wrong polarity of the connection. 2. Damaged communication cable. 3. Bad connection of the transducer cable. 	<ol style="list-style-type: none"> 1. Check connection and polarity of the handshake lines. 2. Test/replace cable. 3. Check if the transducer is connected to the transceiver unit terminal according to colour diagram in appendix.
Status screen shows Transmit/Receive (TX RX)	<ol style="list-style-type: none"> 1. No connection data lines to the terminal (XMITA/XMITB, RECEIVEA/RECEIVEB) or wrong polarity of the connection. 2. Damaged communication cable. 	<ol style="list-style-type: none"> 1. Check connection and polarity of the XMIT and RECEIVE data lines. 2. Test/replace cable.
Status screen shows Transmit/Receive (TX RX) Noise	<ol style="list-style-type: none"> 1. Cable is not connected to ground or 0 Volt terminal. 2. Missing connection of one of the RECEIVEA/RECEIVEB wires on the display side or XMITA/XMITB on the transceiver side. 	<ol style="list-style-type: none"> 1. Check cable screen. 2. Check connection of data lines.
Status screen shows Transmit/Receive (TX RX) Noise	<ol style="list-style-type: none"> 1. Defective receiver PCB. 	<ol style="list-style-type: none"> 1. Replace receiver PCB.
Status screen shows Transmit/Receive (TX RX) Noise	<ol style="list-style-type: none"> 1. Lock up of the transceiver micro controller due to overheat or strong source of noise close to transceiver unit. <p>Note: Display cabinet will restart process automatically.</p>	<ol style="list-style-type: none"> 1. Check environmental and noise conditions in the area.
Status screen shows “Receiver PLD rev 0.0.00” in upper right corner	<ol style="list-style-type: none"> 1. Old PLD in Transceiver unit. 	<ol style="list-style-type: none"> 1. Replace PLD with correct version. See “Old PLD version in Transceiver Unit” on page 40.

Symptom	Cause	Remedy
Interface problems		
NMEA input signals are not listed in the NMEA input screen.	1. Wrong polarity of input signals.	1. Swap NMEA input lines.
NMEA input signals are listed in the NMEA input screen, but not accepted by the DL850.	1. DL850 initialization. 2. Irregular message mnemonic. Red: Not recognized.	1. Cycle DL850 power / do a "factory reset" after NMEA connection is established. 2. Check remote (talker) setup.
NMEA output signals are not accepted by the remote system.	1. Remote (listener) setup.	1. Verify correct remote (listener) setup.
Analogue output malfunctions.	1. Incorrect range settings.	1. Verify upper and lower limits in status screen.
Pulse output malfunctions.	1. Incorrect pulse frequency settings.	1. Verify pulse settings in status screen.
Power failure alarm output do not work.	1. Incorrect polarity. 2. Defective output.	1. Swap input lines. 2. Replace terminal board.
Operational alarm output do not work.	1. Incorrect terminal connection. 2. Defective output.	1. Check use of ALNC and ALNO terminals. 2. Replace terminal board.
Basic functionality		
Constantly wrong speeds or no speed.	1. Wrong calibration. 2. Damaged sensor.	1. Check calibration/re calibrate. 2. Replace sensor.
No bottom tracking.	1. Too deep water (> 150 m).	1. See specifications for depth range, " Performance " on page 66.
Bottom tracking is intermittent or erroneous.	1. Marginal gain or power settings. 2. Weather conditions. 3. Transducer installation faulty.	1. Adjust settings. 2. Try adjusting gain and power settings. 3. Check transducer wiring.
No echo gram contour.	1. Echo sounder is switched off.	1. Echo sounder can be switched on in screen Diagnostics menu 3. Note: Not recommended used if other echo sounders are in operation.
Unrealistic aft speed values in docking mode.	1. Wrong setup of ship parameters.	1. Check installation values for over all length and bow to sensor.
No water track, just bottom track.	1. Flashing GPS-BT, too weak signals. 2. Not flashing GPS-BT, sensor failure.	1. Contact manufacturer, if problem persists. 2. Contact manufacturer.

Typical Status Screen Contents

The status screen contain information that will facilitate analysis and correction of several problems. Information from the status and diagnostics screens should be sent by fax/E-mail with any report about functional disturbances.

07:42
T 21.6°C

SKIPPER DL850, software version 04.03.03, Apr 2012
 12.05.12 SW id:dc-8e-86-50 Frequency:270kHz. Receiver PLD rev: 1.0.00

Display Voltages	Installation Settings	Installation Settings
+5VIO : 5.08V	Pulses ch1: 200/nm	Analogue ch1: 0-10V
+12VIO : 12.10V	Speed ForAftWT	Min limit: 0.0kn
+5VCPU : 5.05V	Pulses ch2: 200/nm	Max limit: 20.0kn
+12VCPU : 12.23V	Speed ForAftWT	Speed ForAftWT
Ambient t:Low	Pulses ch3: 200/nm	Analogue ch2: 0-10V
	Speed ForAftWT	Min limit: 0.0kn
		Max limit: 20.0kn
	Language: English	Speed ForAftWT
Link to Transceiver	Vess. spd.un.: knots	Analogue ch3: 0-10V
Handshake (HSIN HSDUT)	Dist units: NM	Min limit: 0.0kn
Transmit/Receive (TX RX)	Depth units: meters	Max limit: 20.0kn
Noise	Sound spd.un.: m/sec	Speed ForAftWT
System	Alarm buzzer: off	
Temperature	Spd alarm ▲: 20.0kn	
Signal Long	Spd alarm ▼: 0.0kn	
Signal Trans	Spd limit ▲: 0.0kn	
Failure time	Spd limit ▼: 0.0kn	
	Hysteresis : 0.0kn	

Not calibrated WT BT Screen status

1 MENU	English LANGUAGE	knots VESSEL SPD	meters ES RANGE	NM DISTANCE	m/sec SOUND SPD
-----------	---------------------	---------------------	--------------------	----------------	--------------------

If it is at all possible to cycle through the screens and observe this information, several assumptions may be made regarding operation of the DL850 system. Although some of the subsystems necessary for this basic system operation may still suffer from minor or intermittent operation disorders, the fact that it is possible to select and observe this screen, indicate correct operation of the following DL850 subsystems:

1. The CPU board is operating.
2. The keyboard and backlight PCBs are working.
3. The keyboard interface part of the I/O PCB is working.
4. The power supplies on the terminal board are basically working.

The information in the red box on previous page, shows the quality of the signals.

- **Link to Transceiver**; shows the internal communication status between display unit and transceiver unit. Errors in this usually refer to a failure in cabling between the display unit and transceiver unit, but can also point to a failure inside the transceiver cabinet. (See “[Installation problems](#)” on page 57 for more information).
- **Temperature** will indicate a failure on the temperature sensor. This can be an early warning of other problems.
- **Signal Longitudinal & Signal Transversal**; these indicate bad or no results from the sets of longitudinal or transversal beams. This may be caused by system failure or bad acoustic conditions. If the problem persists, the self diagnostics should be used to find out if the system has a problem.

The other information on the status screen is a collection of information which may be observed and manipulated with the various screen softkey selections. As a reference, it will often be more convenient to observe the various settings together on this screen than to cycle from screen to screen to check on the softkey texts.

Typical diagnostic screen contents.

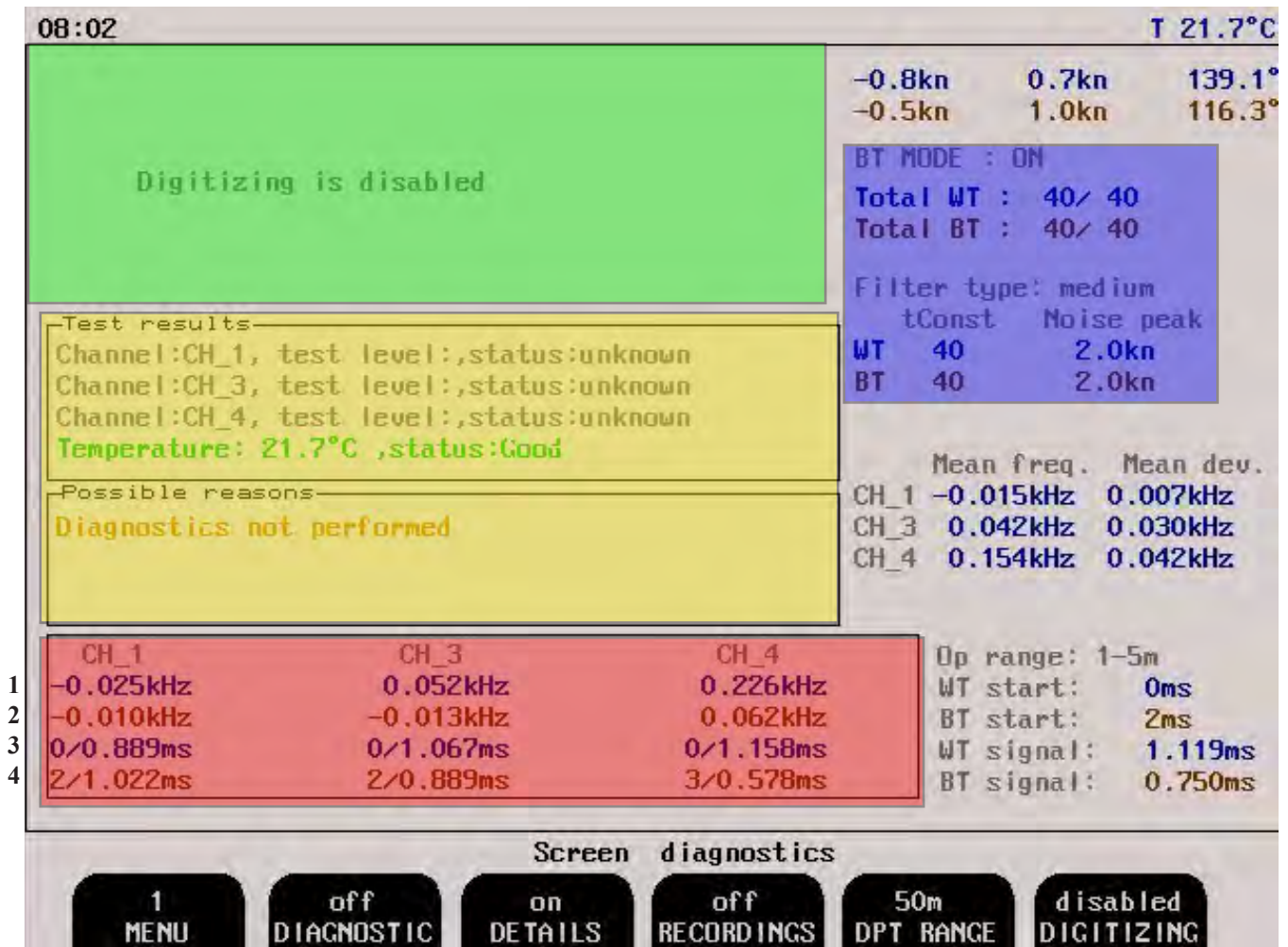

This diagnostic screen show oscillograms from the various transducers. The horizontal axis represent time for the sound to travel down and back from an object or water layer. The vessel is located at the left edge of the grid, and the right edge represent the range. The vertical axis represent the magnitude of the received echo signal.

The diagnostics screen allows the user to diagnose many problems within the system. The screen is split in the following areas.

The red area. The Doppler frequencies and quality parameters:

Each channel has a set of parameters

1. The first line shows the Doppler shift of the water track signal.
2. The second line shows the Doppler shift of the bottom track signal
3. The third line shows the waiting time between ping and sampling for the water track, and is fixed in time. The figure after the ” / “ shows the length of the return signal before it fades. This gives an idea of how much signal is reflected from the water particles. If this is very low, the water is very clean or the transmitted signal is weak.
4. The fourth line is as the third, however for the bottom track. The first number will vary with depth, and from these numbers you can get an idea of the slope of the bottom. It will also show if the bottom track

is triggering from something other than the bottom (for example a fresh water layer or fish). The figure after the “ / “ shows the width of the bottom reflection. This will typically be longer than the transmitted ping and will get longer on sloping bottoms.

The blue area shows the results of the second stage filters which remove data that varies too far from the standard deviation. The filter type has a tConst (time constant) which is the number of pings used to approve a value (a form of rolling time average filter). If data is noisy from ping to ping then some data will be rejected and the limit is set by the noise peak parameter. The Total WT and Total BT shows how many pings were used to get the present value XX/YY, where XX is longitudinal value and YY is transversal value.

Example: If the FILTER soft key (menu 2) is set to medium (40 tConst, 2 kn noise peak) normal operation will give a total WT of 40 - 45. A noisy system will give maybe 60 - 200. The higher the FILTER, the slower the reaction time of the system. High = Good for stability. Low = Good for dynamic operations. The option run.aver disables the noise peak filter.

The green highlighted section allows the user to observe the return signals from each channel in either water or bottom mode. By using the DIGITIZED button in menu 1, each channel can be selected and detection points as well as noise levels can be observed. The bottom and water pulses should reach close to the top of the diagnostic screen, while the noise should be close to the bottom, (first 2 divisions). Higher than this implies the sensor receiver is malfunctioning or is noisy. The time base (horizontal scale) of this screen can be changed using the DPT RANGE button on menu 1.

The yellow highlighted section shows the built in test area for the system, by pressing ‘DIAGNOSTIC’ to “on”, the system will send particular acoustic signals out on all beams and check the return is within specification. In addition, it will analyse the inputs from other sensors. The results will be shown in the ‘test results’ frame, and advice based on the results will be displayed in the ‘Possible reasons’ frame.

Failures

When a failure occurs with the system, this screen allows the user to perform diagnostics. A failure in the transceiver or sensor will be observable on this screen. Typically as follows:

1. **Single beam failure:** A single channel shows eg.”????” (question marks) in all frequency fields for that beam.

This can be a failure in the sensor head or in an individual channel on the transmitter. Check the scope (green) on the relevant channel.

Channel 1 = Fwd

Channel 3 = Starboard

Channel 4 = Port

If one channel is noisy, the sensor element is probably defective. To ensure the failure is the sensor and not the transceiver, swap the transducer channels inside the transceiver cabinet on receiver connector J502. For example if the suspected error is on channel 3, swap channel 1 and 3. Repeat this procedure on transmitter connector J503. (See [“270 kHz Sensor Cable Connection” on page 73](#) for details).

Note: Remember to turn off power at mains before attempting this!

The result of this will probably be that the “?????” (question marks) will move to the new channel. This

confirms that the fault is in the sensor or cable. If it does not move, the fault is within the transceiver cabinet (either transmitter or power card).

Take 3-4 pictures of the screen with a few seconds interval and send by E-mail to manufacturer.

2. All channels “????” and below (question marks) in red area.

If all channels are ????, the fault is most likely the power supply to the sensor. Check all terminals on J502 and J503 are fastened securely and correctly. (See [“270 kHz Sensor Cable Connection” on page 73](#) for details.

If the temperature is also wrong (e.g. -4) the problem is most likely the sensor power supply. Measure the + - 9V power supply to the sensor (pins J502 p 20 - 21 and 23 - 21) with and without the sensor wires attached. If the voltage drops considerably with the sensor power attached, the sensor is most likely faulty, although the power card is also suspected. If the problem is not identified here, refer to further instructions available as a data bulletin on the SKIPPER web site.

In addition to runtime Built in Tests (BIT) (see Status screen), the system can be made to run a dedicated self test routine. This BIT involves the system running a number of test routines and ping types to analyse the electronics, the transducer and the acoustics of the system. It will take the system out of operational mode for around 30 seconds, and present a report in the window. During the test, the word DIAG will be displayed as a warning on the screen. The following errors are possible:

“Troubleshooting was not completed” – the procedure has not been activated yet

“No faults found” – all transducer elements are operating normally

“Transceiver link error” - transceiver communication problem

“Missing +9 VOLT to the transducer”

“Missing -9 VOLT to the transducer”

“or Damaged all transducer elements”

“or transducer cable is not connected”

“Damaged all transducer elements”

“Damaged transducer element(s)”

“or Bad connection of the transducer cable”

“Damaged temperature sensor”

Important note: Since the system status definition is based on the statistical experimental results (not direct measurements of the parameters), the conclusions may be somewhat subjective. Therefore, it is ALWAYS advisable for the service personnel to use alternative validation methods before replacing the transducer. Such method is measuring of the transmitter outputs on all channels.

Also note, that based on the future experience some of the key parameters of this algorithm (test gain setting, signal threshold levels etc) can be changed.

Master reset procedure.

In some cases the display cabinet may get “confused”, or the user has “adjusted” too much. Performing a master reset procedure will return all values to factory default settings.

Important note: Before performing this, note your calibration settings, and setup for inputs and outputs as these will be lost during this procedure.

- Switch off the display unit using the internal toggle switch(es) and wait a few seconds.
- Then press down and keep pressed the softkey to the far right and far left (no. 1 and 6) in the upper row on the keyboard (softkeys).
- Turn “on” the display unit, and keep the two softkeys pressed down until the screen shows the normal picture. This may take as long as app. 30 seconds.
- You should now normally hear 4 “beeps”.

Note: You will now have to re-apply your settings for calibration, input/output and screen settings

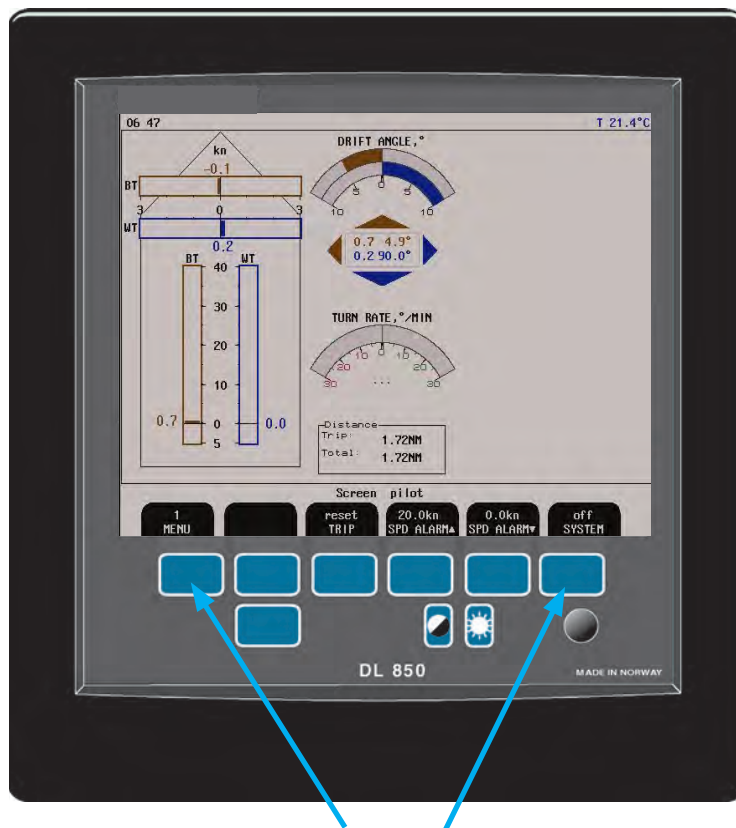

Master reset: Press down these two softkeys and keep them pressed during the “power-up” sequence.

8. Specifications

Dimensions

Transducer, 3 beam	D x H	99 x 115 mm.
3 x 270 kHz, beam angle 10°	Mounting	Sea valve/tank/retrofit.
	Cable length	40 m.
	Weight	app. 10 kg (w/cable).
Transceiver cabinet	H x W x L	450 x 300 x 260 mm.
	Weight	app. 15 kg.
Operator unit cabinet	Height, front	340 mm.
	Width	320 mm.
	Depth	170 mm.
	Weight	app. 10 kg.
Operator unit cabinet		
	Cut-out for flush mounting	H x W: 324 x 304 mm.
	Corner radius	4 mm.

Functional Properties

Display	<ul style="list-style-type: none"> 150 x 200 mm (10.4 inch) LCD with adjustable backlight, 640 x 480 pixels.
Supply voltage	<ul style="list-style-type: none"> 115/230 V AC. 24 V DC (20-32 V)
Power consumption operator unit	<ul style="list-style-type: none"> 50 W at 24 V DC. 70 W at 115/230 V AC.
Speed alarms	<ul style="list-style-type: none"> High and low limits.
Calendar/clock	<ul style="list-style-type: none"> Year-month-day/hours-minutes-seconds (24 hour system).
Interface outputs	<ul style="list-style-type: none"> 10/100/200/400/1000 pulses per nautical mile. Analogue 4 - 20 mA and 0 - 10 V. IEC 61162-1:2007(E) (NMEA 0183) (RS-422). Alarm relay change-over contact, max. 24 V 300 mA. Output for VGA repeater.
Interface inputs	<ul style="list-style-type: none"> IEC 61162-1:2007(E) (NMEA 0183) (RS-422).
Languages	<ul style="list-style-type: none"> English.
Options	<ul style="list-style-type: none"> IR300 digital speed repeater. CD401 LR digital speed repeater.
Protection	<ul style="list-style-type: none"> IP 22

Performance

Speed range	+/- 40 knots, (under favourable installation and sea conditions up to +/- 50 knots).
Depth range for water track	> 1.5 m.
Maximum roll angle	+/- 10 degrees.
Maximum pitch angle	+/- 5 degrees.
Depth range for bottom track	2 - 150 m.
Digital resolution	0.1 knots.
Digital screen resolution	<10 m: 0.01 m.
	>=10 m < 100 m: 0.1 m.
	>=100 m: 1 m.
Speed and distance accuracy	0.2 knots or 2 %, whichever is greater.
Measuring accuracy	Better than 1 %

Note: The performance widely depends on the hydro acoustic properties of the water column (aeration turbulence, depth, etc.), bottom conditions (sea-bed material, steepness of topography) and vessels rolling and pitching. These effects can lead to occasional failure of the system or to incorrect indication of speed and distance (unstable or too low values).

Note: The stated data for depth ranges and accuracy are not valid for unfavourable conditions. Since the speed accuracy depends on the sound speed (affected by salinity and water temperature), it is important to adjust (manually) this parameter for particular operation area, (see "[Screen calibration, Menu 3, mounting settings.](#)" on page 27 for details).

Environmental

Transducer and transceiver cabinet

Operating temperature	-15 - 55°C.
Storage temperature	-20 - 70°C.
Protection, transducer	6 bar IP 68.
Protection, parts inside hull	IP 56.
Protection transceiver cabinet	IP 22.

Operator unit cabinet

Operating temperature	-15 - 55°C.
Storage temperature	-20 - 70°C.
Humidity	10 - 90 % relative, no condensation.

9. Service

- All service requests should be made to the local provider or representative. Contact details on title page.
- Adjustments and repairs should only be performed by qualified service engineers.
- Unqualified repair attempts will void the warranty.

Additional diagnostics aids can be provided by your local representative or by the manufacturer (contact details on title page). If service is required, please ensure the service centre is given:

- Serial and part number(s) of all affected parts.
- If possible, photos of screen Calibration, screen Status and screen Diagnostics.
- Sensor mounting type, (tank or sea valve).
- Vessel name.
- Problem description.
- Contact information for vessel bridge.

10. Appendix 1

Miscellaneous Installation Diagrams

Following diagrams, drawings and pictures are included:

- Fig. 10.1. Picture of transceiver unit showing PCB positions. See [“PCB positions in Transceiver Unit” on page 69.](#)
- Fig. 10.2. LEDs on PCBs in the transceiver unit. See [“LEDs on PCBs in Transceiver Unit” on page 70.](#)
- Fig. 10.3. System overview. See [“DL 850 System Overview” on page 71.](#)
- Fig. 10.4. Interconnection diagram between the operator unit and the transceiver unit. See [“Operator Unit - Transceiver Unit Interconnection” on page 72.](#)
- Fig. 10.5. Interconnection diagram between sensor and the transceiver unit. See [“270 kHz Sensor Cable Connection” on page 73.](#)
- Fig. 10.6. Dimensional drawing of transceiver unit. See [“Transceiver Unit Dimensions” on page 74.](#)
- Fig. 10.7. Dimensional drawing of operator unit. See [“Dimensional Drawing Cabinet” on page 75.](#)
- Fig. 10.8. 115/230 V selection on backplane inside Transceiver Unit. See [“115/230 V selection on backplane inside Transceiver Unit” on page 76.](#)

For bottom part installation, there are separate manuals. All manuals (examples below) available on manufacturers homepage. (See title page for details).

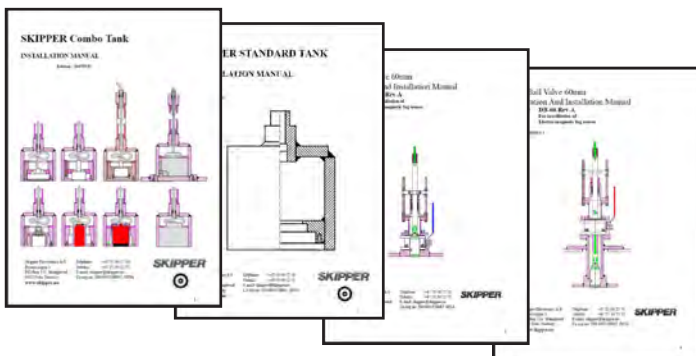

PCB positions in Transceiver Unit



Fig. 10.1 PCB positions in Transceiver Unit

LEDs on PCBs in Transceiver Unit

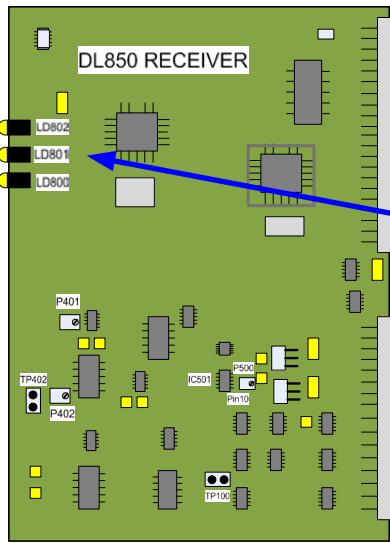

LEDs on Receiver Board

- LD 802: CPU Reset
- LD 801: Transmit Data
- LD 800: Program Download

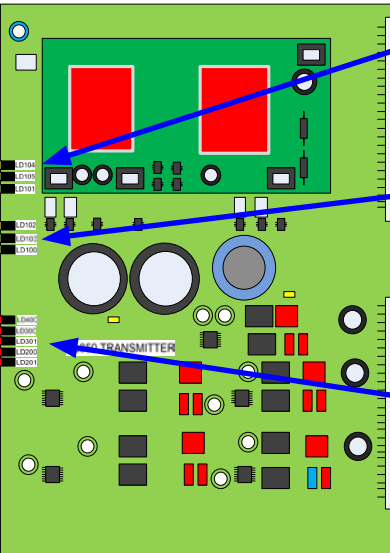

LEDs on Transmitter Board

- LD104: Echo Sounder 100 % Power
- LD105: Echo Sounder 25 % Power
- LD101: Echo Sounder Power active
- LD102: Speed Log 100 % Power
- LD103: Speed Log 25 % Power
- LD100: Speed Log Power active
- LD400: Ch 5 active } Channel 5:
270: Not Used (GND)
540: ES (Echosounder)
- LD300: Ch 3 active } Channel 3:
270: Strb Aft
540: Strb
- LD301: Ch 4 active } Channel 4:
270: Port Aft
540: Port
- LD200: Ch 1 active } Channel 1:
270: Fore
540: Fore
- LD201: Ch 2 active } Channel 2:
270: Not Used (GND)
540: Aft

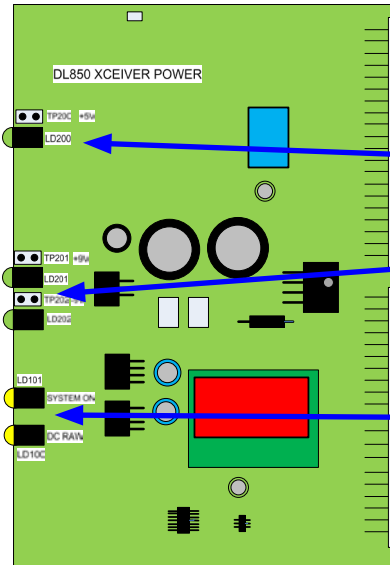

LEDs on Power Board

- LD 200: +5V
- LD201: +9V
- LD202: -9V
- LD101: System On
- LD100: DC Raw

Fig. 10.2 LEDs on PCBs in Transceiver Unit

DL 850 System Overview

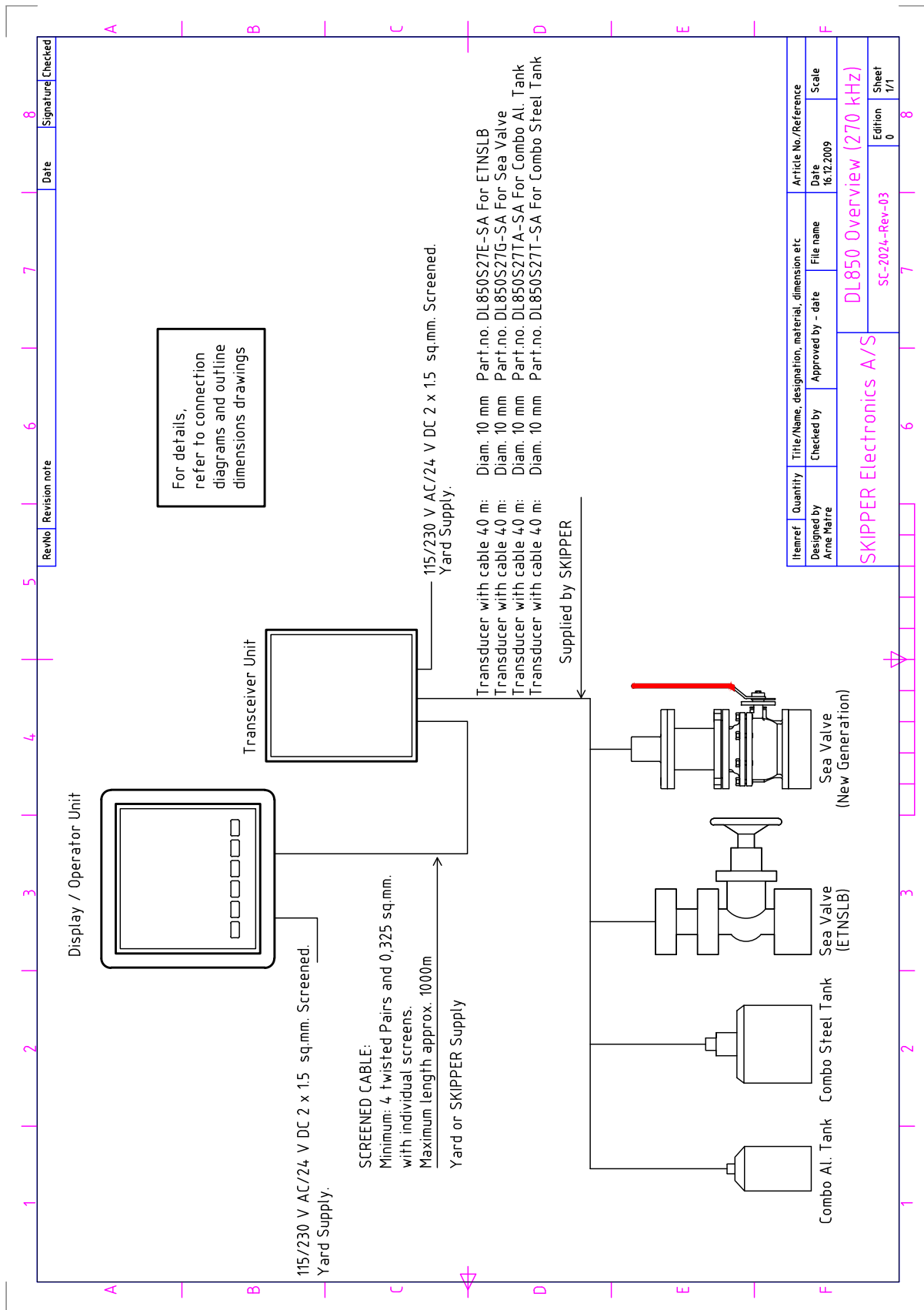

Fig. 10.3. System overview

Operator Unit - Transceiver Unit Interconnection

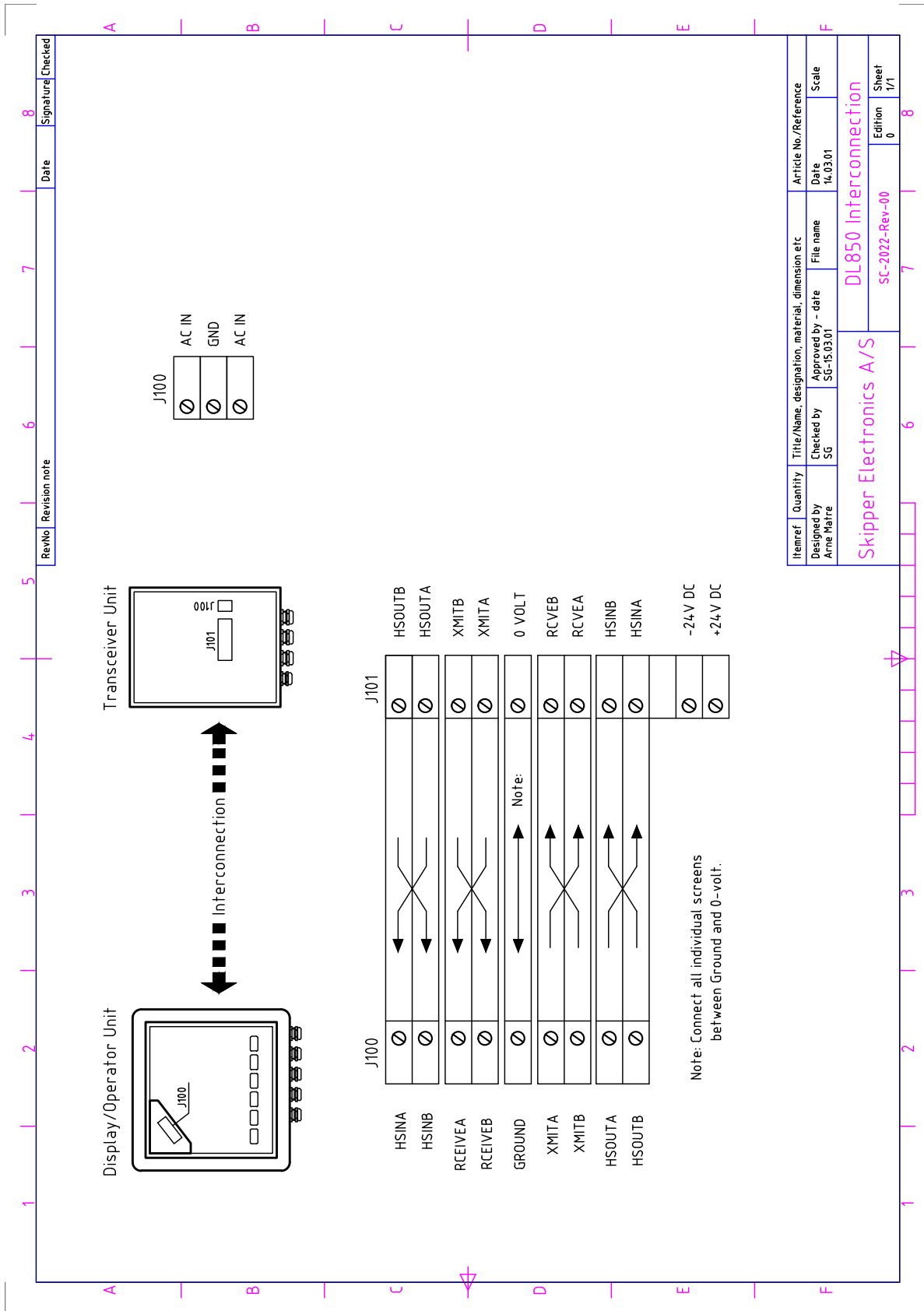

Fig. 10.4. Transceiver unit - operator unit interconnection

270 kHz Sensor Cable Connection

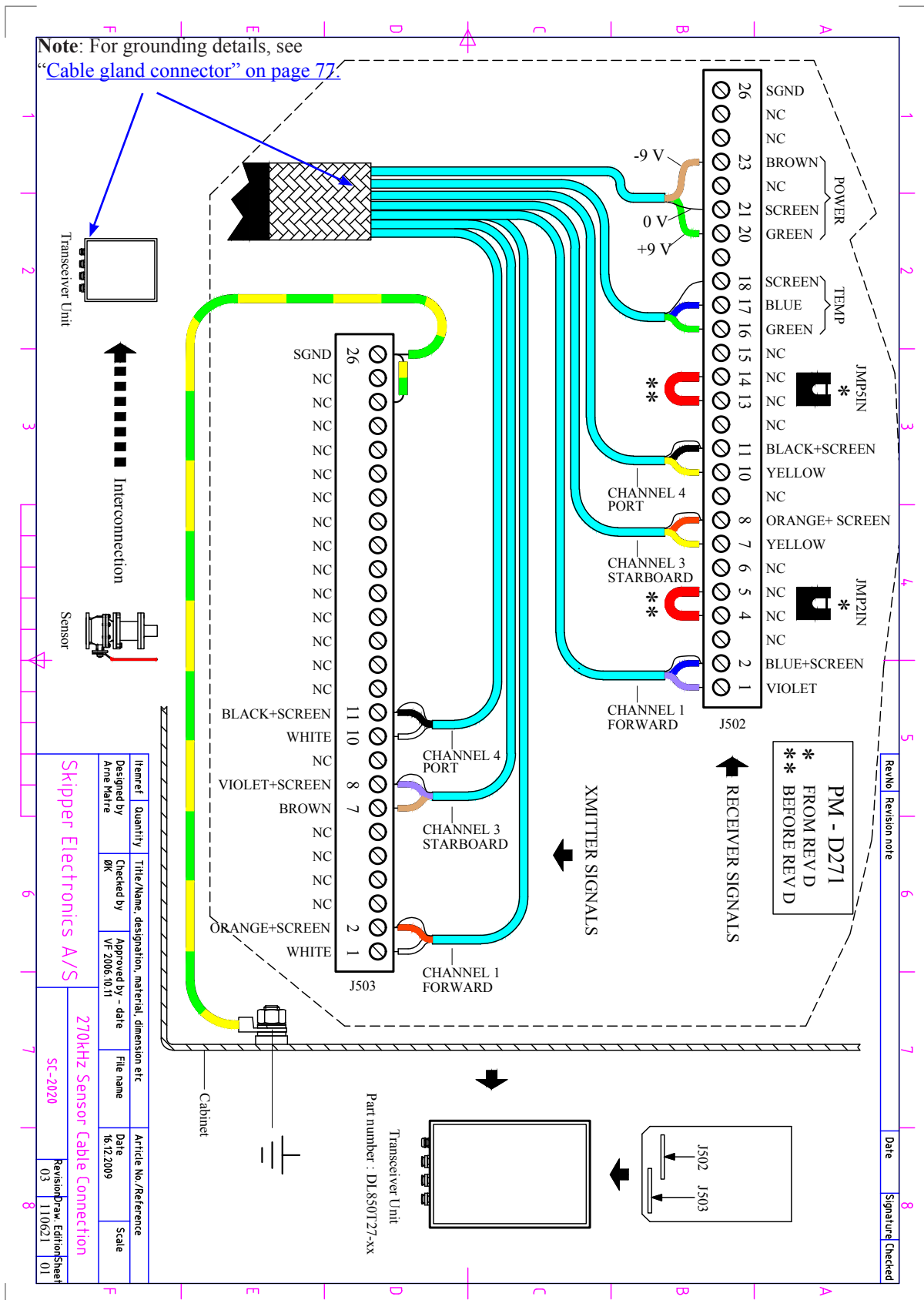

Fig. 10.5. 270 kHz Sensor Cable Connection

Transceiver Unit Dimensions

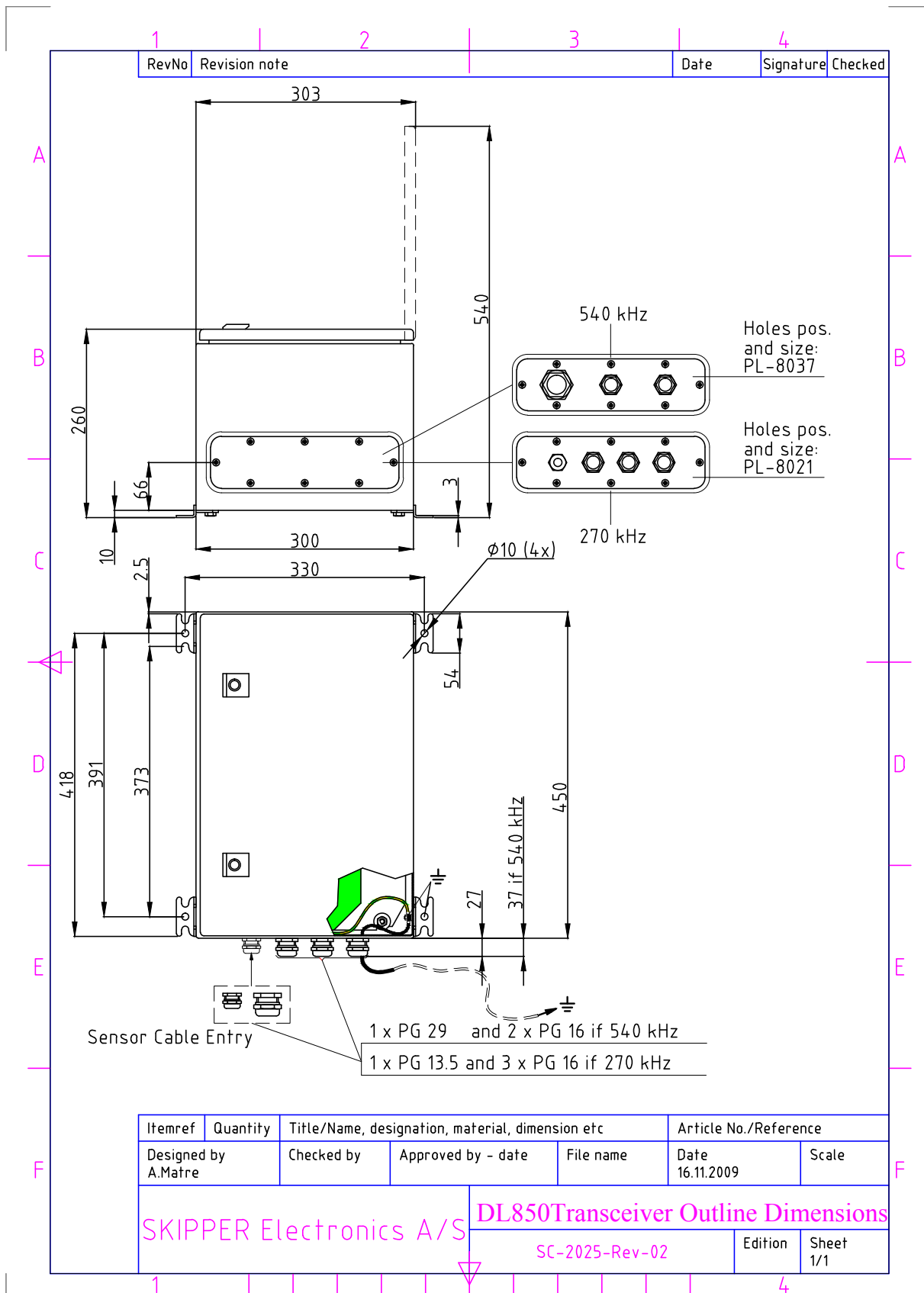

Fig. 10.6. Transceiver Unit Dimensions

Dimensional Drawing Cabinet

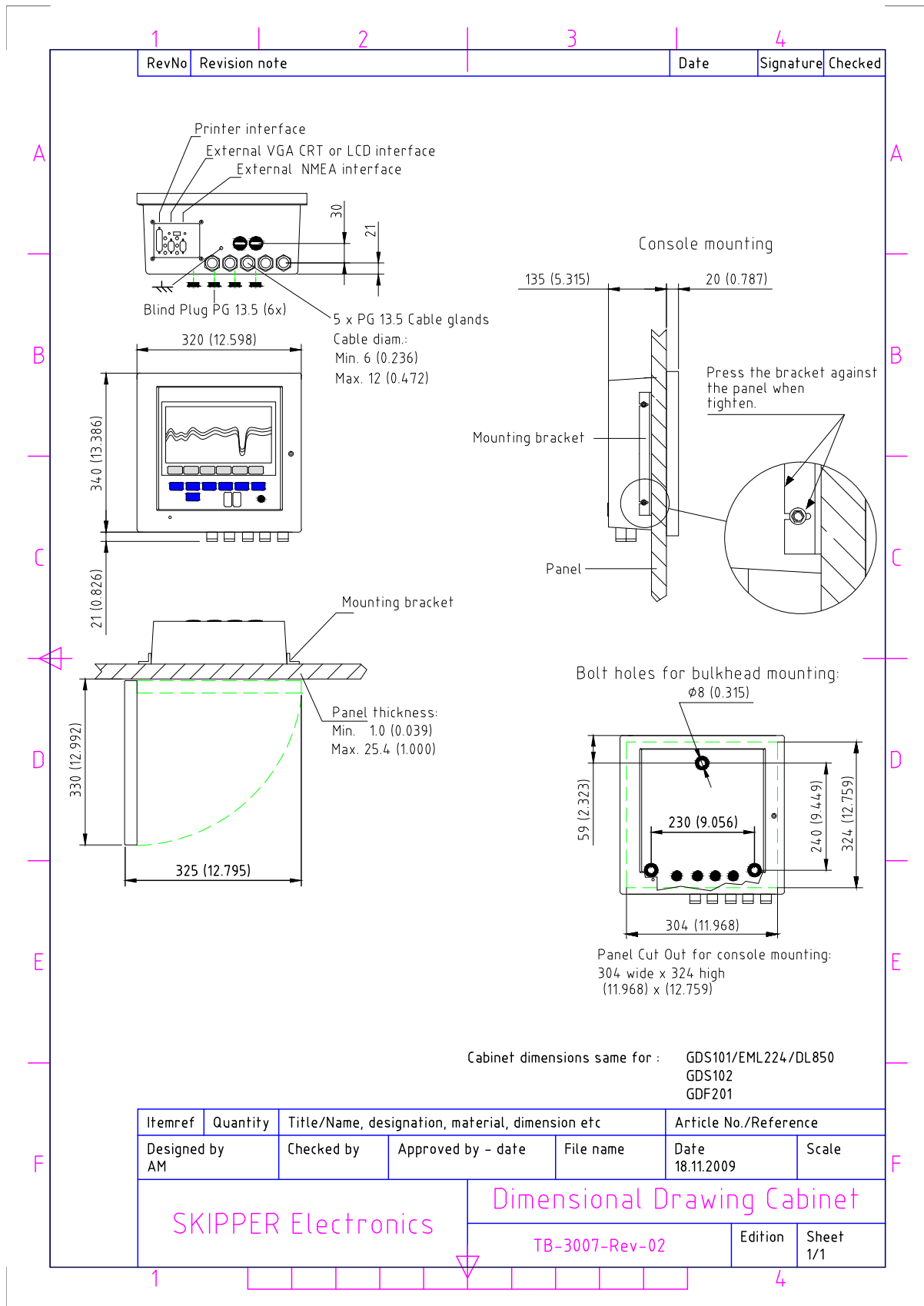

Fig. 10.7. Cabinet Dimensions

115/230 V selection on backplane inside Transceiver Unit

If the AC power system is 115 V, the Transceiver unit may be prepared for 115 V AC by re-connecting the connectors J102, J103 as shown in figure 10.8.

This figure also shows position of fuses for 115/230 V AC and 24 V DC. These fuses are normal 5 x 20 mm glass fuses.

- AC supply:** FS100, FS101 230 V 0.5 A slow blow. (Standard)
 115 V 1 A slow blow.
- DC supply:** FS102 24 V 3.15 A slow blow. (Standard)

When the installation is complete, and power is connected to the Transceiver unit, the appropriate power switch by the power terminals is switched on. Both 115/230 V AC and 24 V DC power may be connected and switched on at the same time. If one of these supplies shuts down, changeover is automatic.

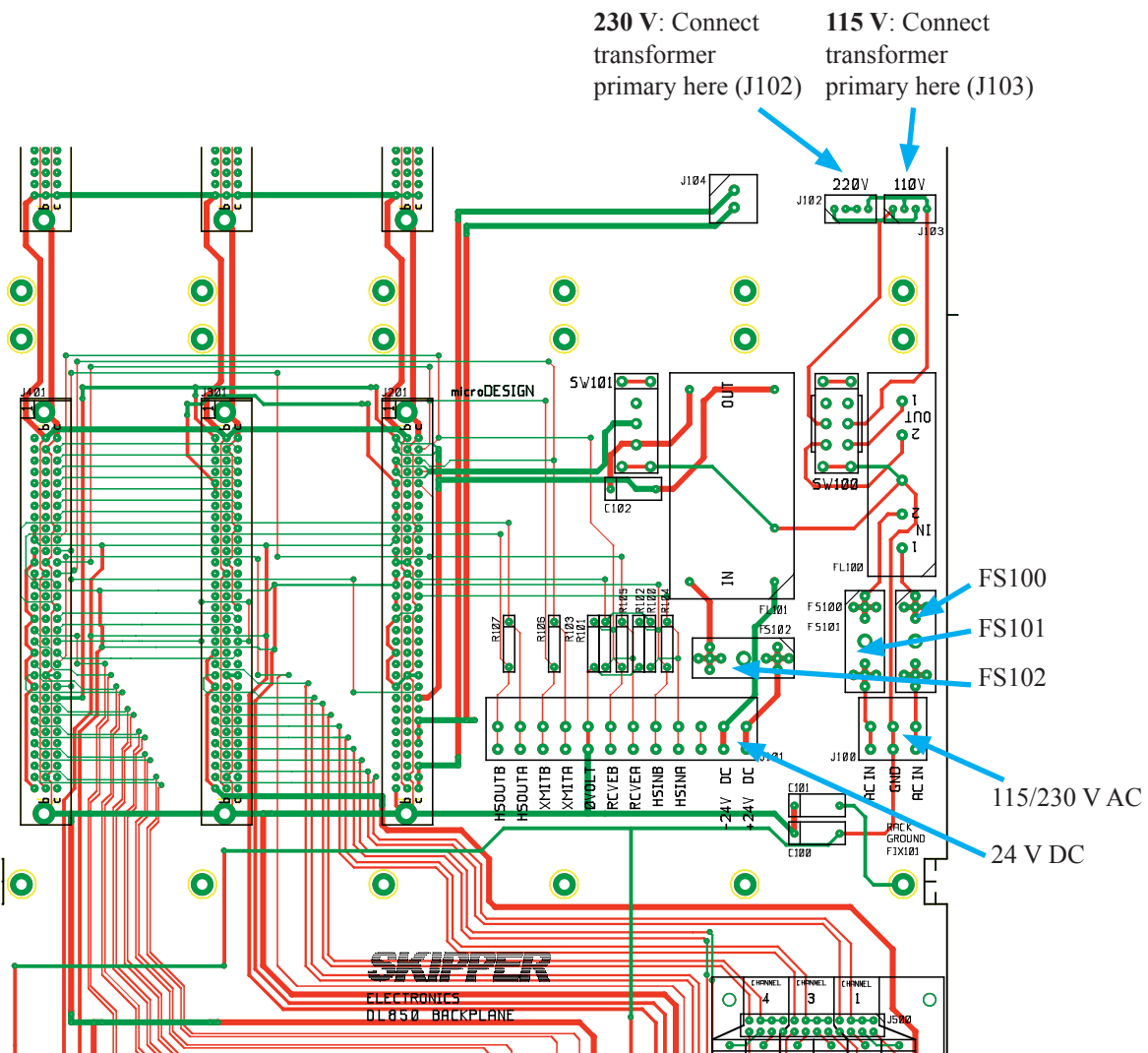
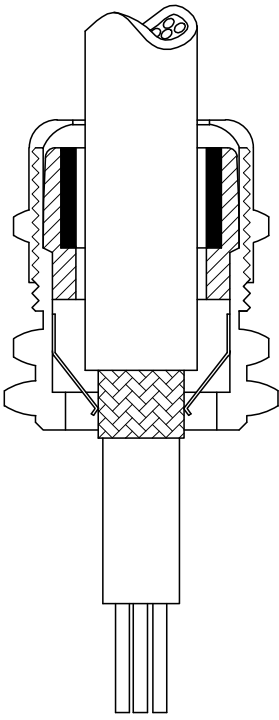

Fig. 10.8. 115/230 V selection on Transceiver unit backplane

Cable gland connector

	1	2	3	4		
RevNo	Revision note			Date	Signature	Checked

1. Straight braided screen



2. Twisted backwardbraided screen

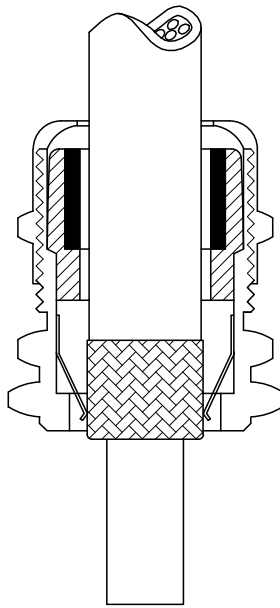

The assembly of cable gland is quick and easy:

1. Partially expose the braided screen by removing the outer sheath of the cable at a length of approx. 10 mm
2. Insert the cable through the dome nut and the gland body until the contact spring is pressed against the braided screen.
3. Firmly screw on dome nut .

Cable glands play an important part in safeguarding EMC requirements where cables and leads enter into a shielding system. They have to ensure a permanent connection with very low ohmic or inductive resistance between the cable shield and the housing potential.

Itemref	Quantity	Title/Name, designation, material, dimension etc	Article No./Reference			
Designed by AM	Checked by VF	Approved by - date VF - 2006.12.18	File name	Date	Scale	
SKIPPER Electronics AS			EMC Cable Gland Connection			
			TB-3015	Revision 00	Draw. edition xxx	Sheet 01

Fig. 10.9 Cable gland connection

11. Appendix 2

Upgrading Software

New software versions are released from time to time. The DL850 with Compact Flash (CF) can be updated by performing the following software upgrade procedure.

1. If you have received a programmed compact flash, skip stage 2.
2. Newest software may be downloaded from the web <http://www.skipper-service.no/skipdoc/skipdoc.php>. Under “software” you will find your equipment type. Also copy the latest version of startup.exe into the root folder..

Note: Standard Compact Flash reader is needed to be attached to the PC.

Note: It is possible to use the Compact Flash card, which is already installed in the display unit.

3. Switch OFF the mains of the display unit and insert Compact Flash card with the new software on it.
4. Press the “hidden” button inside the cabinet (mounted on the solder side of the keyboard). Keeping the hidden button pressed, switch ON the mains in the display unit and keep the button pressed while the message “You may release the upgrade button” appears in the lower part of the screen. If a new setup.exe is to be loaded, follow the on screen instructions.
5. Release the hidden button. After few diagnostic text messages, the list of available software versions will appear in the lower part of the screen as in example below.
6. Note: If the bootloader does not find any file with the software on the Compact Flash, the presently installed version will start automatically. In this case, make sure, that the upgrade and setup file has been copied correctly on the Compact Flash and repeat procedure.

4.03.03	4.03.00
External	Active

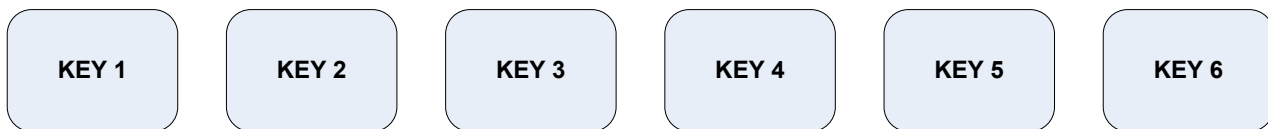

7. Select a software version, which you would like to install. Normally, it is possible to chose one out of two: the version, which is currently installed in the internal memory (indicated as Active) and the upgrade version (indicated as External). The version name is displayed in the upper line of the text lines, located just above the corresponding softkey. In the example above, soft key #1 should be pressed to select the latest software version.
8. Confirm selection by pressing YES button (or go back to selection, pressing NO).
9. Press any button to start the upgraded software (or it will start automatically in 5 seconds).
10. Note: The file with a previous software version will be copied back to the Compact Flash card, so it would be possible to re-install it in the similar manner, if desired.



Upgrading software (summary):

- Insert CF with new software in external MESA board.
- Switch “On” mains inside display unit while pressing “hidden button” on rear side of keyboard.
- Follow instructions on screen.

CPU PCA-6742VE setup

- Connect a PC keyboard and a VGA screen to the CPU board.
- Switch “On” the unit while pressing “Delete” key on the PC keyboard.
- Do not release the “Delete” key before the “Setup” picture is present on the screen.

(Bios version 1.12). The PCA 6742 has the default settings with the following changes. Start by loading the optimized defaults, and then change the following:

Standard CMOS FEatures

Date: Change to todays date

Time: Change to time now

Halt on: No errors

Advanced BIOS Features

- a. Hard Disk priority [Press enter] – Press enter
 - i. 1 should be ch.1 M.
 - ii. 2 should be ch 0 M.
- b. First Boot Device [Hard Disk]
- c. Second Boot Device [Hard Disk]
- d. Boot other device [Disabled]

Advanced Chipset features

- a. SMI712 VGA Settings [Press Enter] – Press enter
 - i. SMI712 VGA Monitor [Simul monitor]
 - ii. Panel resolution Mode [640x480 TFT]
- b. USB Device Setting [Press Enter] – press enter
 - i. USB1.0 emulation [Disabled]

Integral Peripherals

- a. Onboard serial Port 3 [enter]
 - i. Change to [2E8/IRQ9]
- b. Onboard serial Port 4 [enter]
 - i. Change to [3E8/IRQ5]
- c. Parallel Port Mode [EPP]
- d. EPP Mode Select [EPP1.9]

PnP/PCI Configurations

- a. Resources Controlled By [Manual]
- b. IRQ Resources [Enter]
 - i. IRQ – 7 assigned to [Legacy ISA]
 - ii. IRQ – 10 assigned to [Legacy ISA]
 - iii. IRQ – 11 assigned to [Legacy ISA]
- c. NO DMA

PC Health Status

- a. Case Open Warning [Disabled]

SAVE SETTINGS AND EXIT

12. Appendix 3

The echo sounder function

The echo sounder (ES) function on “screen Pilot” is disabled by default, and the control softkey (ES MODE) on “screen Diagnostics”, “menu 3” is not available.

To enable the ES MODE soft key 3 (“screen Diagnostic, menu 3”), first set the DETAILS soft key 2 in screen Diagnostics menu 1 to “On”, then press the “hidden button” (inside the cabinet) and keep it pressed for about 12 seconds (third beep must be heard while pressed). Now, the ES MODE soft key 3 in “screen Diagnostics, menu 3” is visible. Default soft key 3 value is “Off”, set to “On for activation of ES MODE. If the same procedure is repeated once more, the ES softkey 3 will not be visible again. In this case the echo sounder presentation will also be removed from the screen.

Note: The ES function must be disabled on screen diagnostics menu 3 before disabling the buttons.

The screenshot shows the 'Screen pilot' interface with the following data:

- Time: 06:51
- Speed: 13.6°/min
- Temperature: T 9.7°C
- Drift Angle: 20.1 1.8°, 20.3 1.4°
- Turn Rate: 13.5°/MIN
- Distance: Trip: 453041.52NM, Total: 36442.85NM
- Depth: 31.1m
- BT: -0.6, WT: -0.5
- BT: 20.1, WT: 20.3

ES MODE activation:

- First, set DETAILS “On” in “screen Diagnostics” menu 1.
- Then press “hidden button” inside cabinet until 3 beeps are heard.
- Finally set ES MODE to “On” in “screen Diagnostics” menu 3

ES MODE active in “screen Pilot”

DEMO Screen pilot

1 MENU, reset TRIP, 20.0kn SPD ALARM▲, 0.0kn SPD ALARM▼, off SYSTEM

The various softkey menus are selected by pressing repeatedly the MENU button on the left side of the softkey menu. The number on the button (1 – 2) indicates present active menu.

Screen pilot, Menu 1, trip/speed alarm.

Softkey	Name	Range/value	Default value	Description	Activate with hidden button
1	MENU	1 - 2	1	Menu 1 is selected.	
2				Not used.	
3	TRIP	Reset		Trip distance counter reset.	
4	SPD ALARM ▲	-48.4 - 48.6 kn	20.0 kn	High speed alarm.	
5	SPD ALARM ▼	-48.6 - 48.4 kn	0.0 kn	Low speed alarm.	
6	SYSTEM	On/Off	On	Turn system off.	

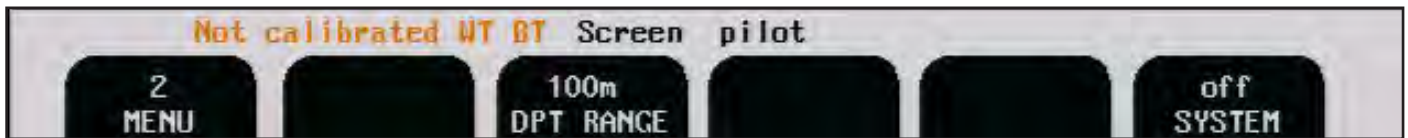

Screen pilot, Menu 2, ES mode settings.

Softkey	Name	Range/value	Default value	Description	Activate with hidden button
1	MENU	1 - 2	2	Menu 2 is selected.	
2				Not used	
3	DPT RANGE	10 - 230 m	100 m	Depth range for ES mode. (Note: Only active when ES MODE is enabled/On. See below, screen diagnostics menu 3, softkey 3).	
4				Not used.	
5				Not used.	
6	SYSTEM	On/Off	On	Turn system off.	

Additional settings on Screen Diagnostics, menu 3

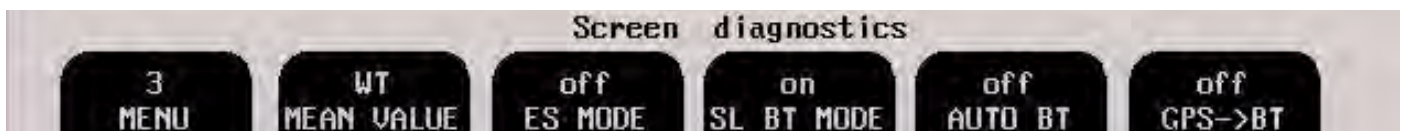

Screen Diagnostics, Menu 3, ES mode, SL BT mode, GPS->BT

Softkey	Name	Range/value	Default value	Description	Activate with hidden button
1	MENU	1 - 3	3	Menu 3 is selected. Note: Use encoder to get access to menu 3.	
2	MEAN VALUE	WT/BT	WT	Toggle between WT and BT for the information showing mean frequency and deviation for last 100 samples.	Active when DETAILS is "on" in "screen Diagnostics" menu 1.
3	ES MODE	On/off	Off	Turn ES mode on/off.	Yes (3 beeps), also please in "screen Diagnostics" menu 1 set DETAILS to On
4	SL BT MODE	On/off	On	Enabling/Disabling individual BT samples, which are only executed, when the operating range is 25 m or lower. Can be used for trouble shooting and factory testing. Must be switched on at normal operation.	Active when AUTO BT is off.
5	AUTO BT	On/off	On	Toggle automatic bottom track. If switched on, bottom track sampling rate is automatically reduced if the present water depth is greater than bottom track operating range. If AUTO BT is switched off, bottom track function will operate continuously, but still only give BT speed indications within the range for bottom track.	Yes (2 beeps)
6	GPS->BT	On/off	Off	This softkey allows the user to substitute longitudinal BT value with GPS data if bottom track is lost. The transversal value will be fixed to 0 knots.	Yes (3 beeps)

13. Notes

A series of horizontal dashed lines for writing notes.

14. Index

Symbols

115/230 V selection on backplane inside Transceiver unit 76
 115/230 V selection on Combo Terminal board 36
 270 kHz Sensor Cable Connection 73

A

Activation of the hidden menus 52
 AC Voltage selection 37
 Additional settings on Screen Diagnostics, menu 3 81
 Alarm acknowledgement 32
 Alarm buzzer 32
 Alarm connections 47
 Alarm relay 41
 Alarms 7
 Analogue interfaces 42
 Analogue output 33
 Analogue outputs and log pulse outputs range selection 48
 ANA MAX 24
 ANA MIN 24
 ANA MODE 24
 AUTO BT 29, 81

B

Backlight adjustment (brightness) 31
 Back-up Battery Jumper JP200 38
 BAUD 20
 Bottom Track Characteristics 30
 BOW<->SENS 23
 BT MEASUR. 27
 BT NOISE.PK 29
 BT REAL 27
 BT tCONST 29
 Built in test (BIT) 33
 BUZZER 23

C

Cable gland connector 77
 CALIBR 26
 Calibration procedure 51
 Calibration routine 52
 CALIBR DIS 26
 CALIBR NUM 27
 Clock and Calendar Settings 32
 COM 19, 20
 COM ERROR 20
 CPU PCA-6742VE setup 79

D

DATA 20
 DAY 23
 Day/Night 31
 Depth range 32
 DETAILS 28
 DIAGNOSTIC 28

Diagnostic functions 33
 DIGITIZING 28
 Dimensional Drawing Cabinet 75
 Dimensions 65
 DISPLAY 19
 DISTANCE 22, 25
 DL 850 System Overview 71
 Docking Function - Option 30
 Docking option parameter setup 50
 Doppler Log Principle 30
 DPT RANGE 28, 81
 DRAUGHT 23

E

Echo sounder option 30
 Environmental 66
 ES MODE 81
 ES RANGE 22

F

Failures 62
 Fig. 1.1 Operator unit, panel layout. 8
 Fig. 1.2 System Diagram 9
 Fig. 2.1 Setting and Parameter Entry Flowchart 10
 Fig. 4.1 Voltage selection connectors and fuses, Terminal Board. 37
 Fig. 4.2 Static Memory Battery Jumper, I/O Board. 38
 Fig. 4.3 Function LEDs, on terminal board 39
 Fig. 4.4 Connecting external equipment 44
 Fig. 4.5 Terminal connections 45
 Fig. 4.6 Misc I/O connections 46
 Fig. 4.7 Alarm connections 47
 Fig 6.1 Sea valve alignment 51
 Fig. 10.1 PCB positions in Transceiver Unit 69
 Fig. 10.2 LEDs on PCBs in Transceiver Unit 70
 Fig. 10.3. System overview 71
 Fig. 10.4. Transceiver unit - operator unit interconnection 72
 Fig. 10.5. 270 kHz Sensor Cable Connection 73
 Fig. 10.6. Transceiver Unit Dimensions 74
 Fig. 10.7. Cabinet Dimensions 75
 Fig. 10.8. 115/230 V selection on Transceiver unit backplane 76
 Fig. 10.9 Cable gland connection 77
 FILTER 29
 Fixed Key Functions 31
 Functional Properties 65
 Function LEDs 39
 Fuses 37

G

GPS->BT 81

H

Handling warning 35
 HEAD ERR 27

Heading Error 51
Heading error correction 53
HOURS 23
Hysteresis 33
HYSTERESIS 25

I

Important note 28, 36, 40, 63, 64
INDICATION 15, 16
Inputs 7, 42
Installation 35
Installation Diagrams 68
Installation functions 32
Installation problems 57
Interface problems 58
Interfacing 7, 41
Introduction 6

L

LANGUAGE 22
LEDs on PCBs in Transceiver Unit 70
Link to Transceiver 60
Log Pulse Outputs 41
LONG. SP 25

M

Manual speed calibration 53
Master reset procedure. 64
MEAN VALUE 29, 81
Menu 32
MENU 12, 13, 19, 20, 22, 23, 24, 25, 26, 27, 28, 29
MESSAGE 19
MINUTES 23
Misc I/O connections 46

N

NMEA interface 42
NMEA Setup 48
Non-volatile Parameter Memory 31
NOT CALIBRATED WT BT 26
Note 12, 17, 20, 22, 23, 25, 26, 34, 36, 38, 41, 42, 52, 55, 57,
62, 64, 66, 78, 80

O

Old PLD version in Transceiver Unit 40
Operation 10
Operator Unit 7
Operator Unit and Transceiver Unit Maintenance 34
Operator Unit - Connecting External Equipment 44
Operator Unit Installation 36
Operator unit, panel layout. 8
Operator unit - Terminal connections 45
Operator Unit - Transceiver Unit Interconnection 72
Options 42
OUT MODE 24
OUT NUM 24

OUTPUT 19
Outputs 7

P

Parameter entry 10
PCB positions in Transceiver Unit 69
Performance 66
Power failure alarm 33
Power indication 39
Primary Screens 11
Principal Functions 30
Pulse output 33
PULSES NUM 24

R

Receiver PLD rev: 0.0.00 40
RECORDINGS 28
Repeaters/Slaves 42
Run Aver 29

S

Scope 33
Screen calibration, Menu 1, calibration. 26
Screen calibration, Menu 2, manual override. 27
Screen calibration, Menu 3, mounting settings. 27
Screen com, Menu 1, NMEA setup. 19
Screen com, Menu 2, NMEA com setup. 20
Screen diagnostics, Menu 1. 28
Screen diagnostics, Menu 2, filtering/averaging. 29
Screen diagnostics, Menu 3, settings 29
Screen docking, arrow view (only in docking version). 15
Screen docking, bar graph view (only in docking version). 16
Screen open sea, system. 17
Screen pilot, Menu 1, trip/speed alarm. 12, 80
Screen pilot, Menu 2, ES mode settings. 81
Screen pilot, Menu 2, system. 13
Screen Select 31
Screen shallow water, (only in non docking version). 14
Screen status, Menu 1, units. 22
Screen status, Menu 2, date/time. 23
Screen status, Menu 3, boat setup/buzzer. 23
Screen status, Menu 4, pulse settings. 24
Screen status, Menu 5, analogue settings. 24
Screen status, Menu 6, speed limits and hysteresis 25
Screen status, Menu 7, signal good/signal suspected 25
Screen status, Menu 8, speed test/demo (simulate). 25
Sea valve alignment 51
Semi Automatic calibration 54
Sensor to bow 50
Sensor (Transducer) and Transceiver 6
Service 67
Setup and Function Control Screens 18
SHIP LEN 23
Ship length 50
Signal longitudinal & signal transversal 60
SIGN. GOOD 25
SIGN. SUSP(ECTED) 25

SIMULATE 25
SL BT MODE 29, 81
Soft Key Functions 32
SOUND 27
SOUND SPD 22
SPD ALARM ▲ 12
SPD ALARM ▼ 12
SPD LIMIT▲ 25
SPD LIMIT▼ 25
SPD TEST 25
Specifications 65
Sp(ee)d Alarm 32
Speed limit 33
Speed Limit function 41
Speed limits functionality 33
Standard System Supply 35
START 26
Start-up and system adaption 48
System 22
SYSTEM 12, 13, 14, 15, 16, 17
System Adaption 48
System Diagram 9
System On/Off 32
System Summary 6

YR.MONTH 23

T

Temperature 60
The echo sounder function 80
T° OFFSET 27
Transceiver Unit Dimensions 74
Transducer Installation 36
Transducer Maintenance 34
TRANSV. SP 25
TRIP 12
TRIP BT 26
Trip Reset 32
TRIPS LIST 26
Trouble Shooting 56

U

Units of Measure 48
Upgrading Software 78
User adjusted functions 32
User Maintenance 34

V

VESSEL SPD 22

W

Water Track Characteristics 30
WT MEASUR. 27
WT NOIS.PK 29
WT REAL 27
WT tCONST 29

Y